



Operators and Safety Manual

***Model
450A
450AJ***

3120868
April 24, 2002



FOREWORD

The purpose of this manual is to provide users with the operating procedures essential for the promotion of proper machine operation for its intended purpose. It is important to over-stress proper machine usage. All information in this manual should be READ and UNDERSTOOD before any attempt is made to operate the machine. **YOUR OPERATING MANUAL IS YOUR MOST IMPORTANT TOOL** - Keep it with the machine. **REMEMBER ANY EQUIPMENT IS ONLY AS SAFE AS THE OPERATOR.**

BECAUSE THE MANUFACTURER HAS NO DIRECT CONTROL OVER MACHINE APPLICATION AND OPERATION, PROPER SAFETY PRACTICES ARE THE RESPONSIBILITY OF THE USER AND HIS OPERATING PERSONNEL.

ALL INSTRUCTIONS IN THIS MANUAL ARE BASED ON THE USE OF THE MACHINE UNDER PROPER OPERATING CONDITIONS, WITH NO DEVIATIONS FROM THE ORIGINAL DESIGN. ALTERATION AND/OR MODIFICATION OF THE MACHINE IS STRICTLY FORBIDDEN, WITHOUT WRITTEN APPROVAL FROM JLG INDUSTRIES, PER OSHA REGULATIONS AND APPLICABLE ANSI STANDARDS.



THIS SAFETY ALERT SYMBOL IS USED TO CALL ATTENTION TO POTENTIAL HAZARDS WHICH MAY LEAD TO SERIOUS INJURY OR DEATH IF IGNORED.

Safety of personnel and proper use of the machine are of primary concern, DANGER, WARNING, CAUTION, IMPORTANT, INSTRUCTIONS and NOTE are inserted throughout this manual to emphasize these areas. They are defined as follows:

DANGER

DANGER INDICATES AN IMMINENTLY HAZARDOUS SITUATION WHICH, IF NOT AVOIDED WILL RESULT IN SERIOUS INJURY OR DEATH.]

WARNING

WARNING INDICATES A POTENTIALLY HAZARDOUS SITUATION WHICH, IF NOT AVOIDED COULD RESULT IN SERIOUS INJURY OR DEATH.

CAUTION

CAUTION INDICATES A POTENTIALLY HAZARDOUS SITUATION WHICH, IF NOT AVOIDED, MAY RESULT IN MINOR OR MODERATE INJURY. IT MAY ALSO BE USED TO ALERT AGAINST UNSAFE PRACTICES

IMPORTANT

IMPORTANT OR INSTRUCTIONS INDICATES A PROCEDURES ESSENTIAL FOR SAFE OPERATION AND WHICH, IF NOT FOLLOWED, MAY RESULT IN A MALFUNCTION OR DAMAGE TO THE MACHINE.

IMPORTANT

JLG INDUSTRIES MAY HAVE ISSUED SAFETY RELATED BULLETINS FOR YOUR JLG PRODUCT. CONTACT JLG INDUSTRIES INC. OR THE LOCAL AUTHORIZED JLG DISTRIBUTOR FOR INFORMATION CONCERNING SAFETY RELATED BULLETINS WHICH MAY HAVE BEEN ISSUED FOR YOUR JLG PRODUCT. ALL ITEMS REQUIRED BY THE SAFETY RELATED BULLETINS MUST BE COMPLETED ON THE AFFECTED JLG PRODUCT

Due to continuous product improvements, JLG Industries, Inc. reserves the right to make specification changes without prior notification. Contact JLG Industries, Inc. for updated information.

This page left blank intentionally.

All procedures herein are based on the use of the machine under proper operating conditions, with no deviations from original design intent... as per OSHA regulations.

READ & HEED!

The ownership, use, service, and/or maintenance of this machine is subject to various governmental and local laws and regulations. It is the responsibility of the owner/user to be knowledgeable of these laws and regulations and to comply with them. The most prevalent regulations of this type in the United States are the Federal OSHA Safety Regulations*. Listed below, in abbreviated form are some of the requirements of Federal OSHA regulations in effect as of the date of publication of this handbook.

The listing of these requirements shall not relieve the owner/user of the responsibility and obligation to determine all applicable laws and regulations and their exact wording and requirements, and to comply with the requirements. Nor shall the listing of these requirements constitute an assumption of responsibility of liability on the part of JLG Industries, Inc.

1. Only trained and authorized operators shall be permitted to operate the aerial lift.
2. A malfunctioning lift shall be shut down until repaired.
3. The controls shall be plainly marked as to their function.
4. The controls shall be tested each day prior to use to determine that they are in safe operating condition.

5. All personnel in the platform shall, at all times, wear approved fall protection devices and other safety gear as required.
6. Load limits specified by the manufacturer shall not be exceeded.
7. Instruction and warning placards must be legible.
8. Aerial lifts may be field modified for uses other than those intended by the manufacturer only if certified in writing by the manufacturer to be in conformity to JLG requirements and to be at least as safe as it was prior to modification.
9. Aerial lifts shall not be used near electric power lines unless the lines have been de energized or adequate clearance is maintained.
10. Employees using aerial lifts shall be instructed on how to recognize and avoid unsafe conditions and hazards.
11. Ground controls shall not be operated unless permission has been obtained from personnel in the platform, except in case of an emergency.
12. Regular inspection of the job site and aerial lift shall be performed by competent persons.
13. Personnel shall always stand on the floor of the platform, not on boxes, planks, railing or other devices, for a work position.

*Applicable Federal OSHA regulations for the United States, as of the date of publication of this manual, include, but are not limited to, 29 CFR 1910.67, 29 CFR 1926.20, 29 CFR 1926.21, 29 CFR 1926.28, and 29 CFR 1926.453.

REVISION LOG

Original Issue	- May, 1998
Revised	- August 1, 1999
2-12 and 2-13	- Updated 11-2-99
5-3	- Updated 2-16-00
3-6	- Updated 9-19-00
3-10	- Updated 4-24-02

TABLE OF CONTENTS

SUBJECT - SECTION, PARAGRAPH	PAGE NO.
SECTION - FOREWORD	
SECTION 1 - SAFETY PRECAUTIONS	
1.1 General	1-1
1.2 Driving/Towing.	1-1
1.3 Electrocution Hazard.	1-2
1.4 Pre-Operational	1-2
1.5 Driving	1-4
1.6 Operation.	1-5
1.7 Towing and Hauling	1-8
SECTION 2 - PREPARATION AND INSPECTION	
2.1 General	2-1
2.2 Preparation For Use	2-1
2.3 Delivery and Frequent Inspection.	2-1
2.4 Daily Walk-Around Inspection.	2-5
2.5 Daily Functional Check	2-9
2.6 Battery Maintenance	2-10
SECTION 3 - USER RESPONSIBILITIES AND MACHINE CONTROL	
3.1 General	3-1
3.2 Personnel Training	3-1
3.3 Operating Characteristics and Limitations	3-2
3.4 Controls and Indicators.	3-5
3.5 Placards and Decals	3-11
SECTION 4 - MACHINE OPERATION	
4.1 Description	4-1
4.2 General	4-1
4.3 Engine Operation	4-2
4.4 Traveling (Driving)	4-2
4.5 Steering	4-3
4.6 Parking and Stowing	4-3
4.7 Platform	4-3
4.8 Boom.	4-4
4.9 Lift Up and Platform Level Down Disable Switch Functional Check	4-5
4.10 Shut Down and Park	4-5
4.11 Tie Down and Lifting	4-5
4.12 Oscillating Axle Lockout Test (If Equipped)	4-9
4.13 Towing	4-10
SECTION 5 - OPTIONAL EQUIPMENT	
5.1 Dual Fuel System (Gas Engine Only)	5-1
5.2 Oscillating Axle	5-1
5.3 Platform W/soft Touch Proximity System Bumper	5-1
5.4 Four Wheel Drive	5-1
5.5 Cold Weather Package	5-1
5.6 Travel Alarm.	5-2
5.7 Electric Generator	5-2
5.8 Rotating Beacon	5-2
5.9 Cylinder Bellows	5-2
5.10 Boom Wipers.	5-2
5.11 Hostile Environment Package	5-3
5.12 Motion Alarm	5-3

TABLE OF CONTENTS (continued)

SUBJECT - SECTION, PARAGRAPH	PAGE NO.
5.13 Semi-Track	5-3
SECTION 6 - EMERGENCY PROCEDURES	
6.1 General	6-1
6.2 Emergency Towing Procedures	6-1
6.3 Emergency Controls and Their Locations	6-1
6.4 Emergency Operation	6-2
6.5 Incident Notification	6-2
SECTION 7 - INSPECTION AND REPAIR LOG	

LIST OF FIGURES

FIGURE NO.	TITLE	PAGE NO.
2-1.	Machine Nomenclature	2-3
2-2.	Daily Walk-Around Inspection - Sheet 1 of 3	2-6
2-3.	Daily Walk-Around Inspection - Sheet 2 of 3	2-7
2-4.	Daily Walk-Around Inspection - Sheet 3 of 3	2-8
2-5.	Lubrication Diagram	2-11
2-6.	Torque Chart	2-14
3-1.	Position of Least Forward Stability	3-3
3-2.	Position of Least Backward Stability	3-4
3-3.	Ground Control Indicator Panel	3-6
3-4.	Ground Control Station	3-7
3-5.	Platform Station	3-9
3-6.	Danger and Warning Decal Location	3-12
3-7.	Control Panel Symbols - Sheet 1 of 2	3-15
3-8.	Control Panel Symbols - Sheet 2 of 2	3-16
4-1.	Grade and Sideslope	4-3
4-2.	Functional Check	4-5
4-3.	Machine Tie Down - A Models	4-6
4-4.	Machine Tie Down - AJ Models	4-7
4-5.	Lifting Chart	4-8
4-6.	Drive Disconnect Hub	4-10

LIST OF TABLES

TABLE NO.	TITLE	PAGE NO.
1-1	Minimum Safe Approach Distances (M.S.A.D.) to energized (exposed or insulated) power lines and parts	1-2
2-1	Lubrication Chart	2-12
7-1	Inspection and Repair Log	7-1

SECTION 1. SAFETY PRECAUTIONS

1.1 GENERAL

This section prescribes the proper and safe practices for major areas of machine usage. In order to promote proper usage of the machine, it is mandatory that a daily routine be established based on instructions given in this section. A maintenance program must also be established by a qualified person and must be followed to ensure that the machine is safe to operate.

The owner/user/operator of the machine should not accept operating responsibility until this manual has been read and understood, and operation of the machine, under the supervision of an experienced and qualified person, has been completed. If there is a question on application and/or operation, JLG Industries Inc., should be consulted.

WARNING

MODIFICATION OR ALTERATION OF AN AERIAL PLATFORM SHALL BE MADE ONLY WITH PRIOR WRITTEN PERMISSION OF THE MANUFACTURER.

1.2 DRIVING/TOWING

Before driving the machine, the user must be familiar with the drive, steer and stopping characteristics. This is especially important when driving in close quarters.

The user should be familiar with the driving surface before driving. The surface should be firm and level and grades should not exceed the allowable grade for the machine.

NOTE: *Remember that the key to safe and proper usage is common sense and its careful application.*

The machine is not equipped with provisions for towing. Refer to Section 6 for emergency towing procedures.

SPECIAL NOTE:

WARNING

FAILURE TO COMPLY WITH SAFETY PRECAUTIONS LISTED IN THIS SECTION AND ON THE MACHINE COULD RESULT IN MACHINE DAMAGE, PERSONNEL INJURY OR DEATH, AND IS A SAFETY VIOLATION.

SECTION 1 - SAFETY PRECAUTIONS

Table 1-1. Minimum Safe Approach Distances (M.S.A.D.) to energized (exposed or insulated) power lines and parts

Voltage Range (Phase to Phase)	MINIMUM SAFE APPROACH DISTANCE in Meters
0 to 300V	AVOID CONTACT
Over 300V to 50 KV	3
Over 50KV to 200 KV	5
Over 200 KV to 350 KV	6
Over 350 KV to 500 KV	8
Over 500 KV to 750 KV	11
Over 750 KV to 1000 KV	14

DANGER: DO NOT maneuver machine or personnel inside **PROHIBITED ZONE**. **ASSUME** all electrical parts and wiring are **ENERGIZED** unless known otherwise.

1.3 ELECTROCUTION HAZARD

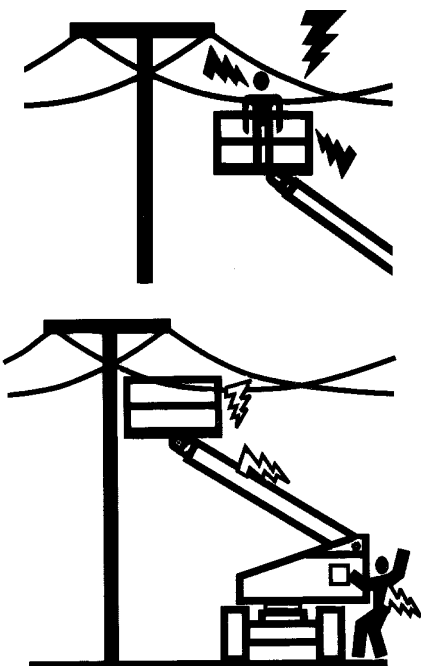

- MAINTAIN SAFE CLEARANCE FROM ELECTRICAL LINES AND APPARATUS. ALLOW FOR BOOM SWAY, ROCK OR SAG AND ELECTRICAL LINE SWAYING. THE MACHINE DOES NOT PROVIDE PROTECTION

FROM CONTACT WITH OR PROXIMITY TO AN ELECTRICALLY CHARGED CONDUCTOR.

- MAINTAIN A CLEARANCE OF AT LEAST 3 M (10 FEET) BETWEEN ANY PART OF THE MACHINE OR ITS LOAD AND ANY ELECTRICAL LINE OR APPARATUS CARRYING UP TO 50,000 VOLTS. 30.5 cm ADDITIONAL CLEARANCE IS REQUIRED FOR EVERY ADDITIONAL 30,000 VOLTS OR LESS.

1.4 PRE-OPERATIONAL

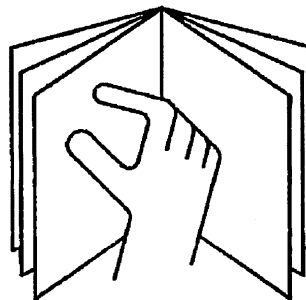

- READ YOUR MANUAL. UNDERSTAND WHAT YOU'VE READ - THEN BEGIN OPERATIONS.
- ALLOW ONLY AUTHORIZED AND QUALIFIED PERSONNEL TO OPERATE MACHINE WHO HAVE DEMONSTRATED THAT THEY UNDERSTAND SAFE AND PROPER OPERATION AND MAINTENANCE OF THE UNIT.

SECTION 1 - SAFETY PRECAUTIONS

- AN OPERATOR MUST NOT ACCEPT OPERATING RESPONSIBILITIES UNTIL ADEQUATE TRAINING HAS BEEN GIVEN BY COMPETENT AND AUTHORIZED PERSONS.
- BEFORE OPERATION, CHECK WORK AREA FOR OVERHEAD ELECTRIC LINES, MACHINE TRAFFIC SUCH AS BRIDGE CRANES, HIGHWAY, RAILWAY AND CONSTRUCTION EQUIPMENT.

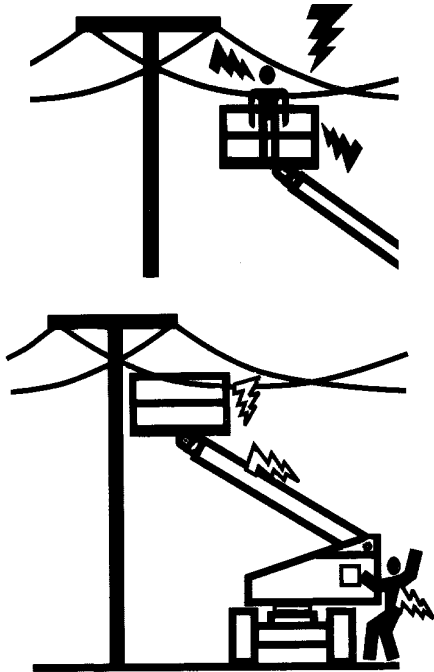

- PRECAUTIONS TO AVOID ALL KNOWN HAZARDS IN THE WORK AREA MUST BE TAKEN BY THE OPERATOR AND HIS SUPERVISOR BEFORE STARTING THE WORK.
- DO NOT OPERATE THIS MACHINE UNLESS IT HAS BEEN SERVICED AND MAINTAINED ACCORDING TO THE MANUFACTURERS SPECIFICATIONS AND SCHEDULE.
- ENSURE DAILY INSPECTION AND FUNCTION CHECK IS PERFORMED PRIOR TO PLACING MACHINE INTO OPERATION.

- NEVER DISABLE OR MODIFY THE FOOTSWITCH OR ANY OTHER SAFETY DEVICE. UNAUTHORIZED MODIFICATION OF THE MACHINE IS A SAFETY VIOLATION.

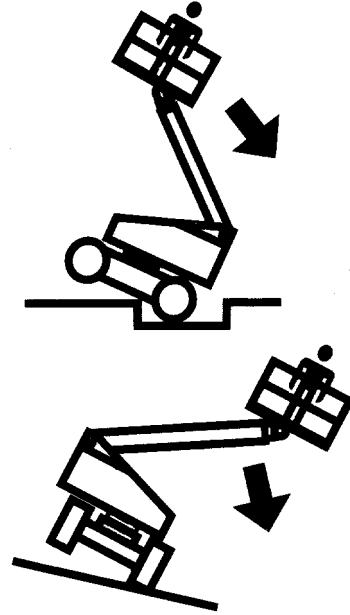

- DO NOT OPERATE MACHINE WHEN WIND CONDITIONS EXCEED 12.5 M/S (30MPH).
- NEVER OPERATE BOOM FUNCTIONS (TELE, SWING, LIFT) WHEN MACHINE IS ON A TRUCK, OTHER VEHICLE, OR ABOVE GROUND STRUCTURE.
- THIS MACHINE CAN BE OPERATED IN NOMINAL AMBIENT TEMPERATURES OF -20° C TO 40° C (0° F TO 104° F). CONSULT FACTORY TO OPTIMIZE OPERATION OUTSIDE THIS RANGE.

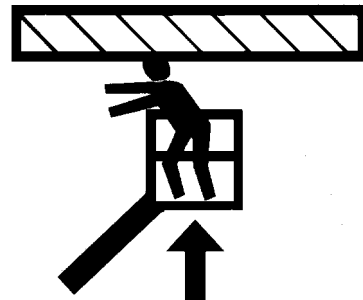

- APPROVED HEAD GEAR MUST BE WORN BY ALL OPERATING AND GROUND PERSONNEL.

SECTION 1 - SAFETY PRECAUTIONS

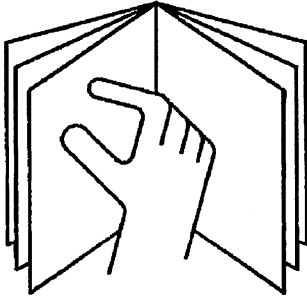

- READ AND OBEY ALL DANGERS, WARNINGS, CAUTIONS AND OPERATING INSTRUCTIONS ON MACHINE AND IN THIS MANUAL.
- BE FAMILIAR WITH LOCATION AND OPERATION OF GROUND STATION CONTROLS.

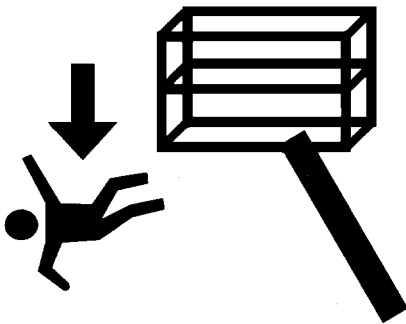

- ALWAYS USE THREE POINT CONTACT WHEN ENTERING OR EXITING THE MACHINE. FACE THE MACHINE WHEN YOU ENTER OR LEAVE. THREE POINT CONTACT MEANS THAT TWO HANDS AND ONE FOOT OR ONE HAND AND TWO FEET ARE IN CONTACT WITH THE MACHINE AT ALL TIMES DURING MOUNT AND DISMOUNT.

1.5 DRIVING

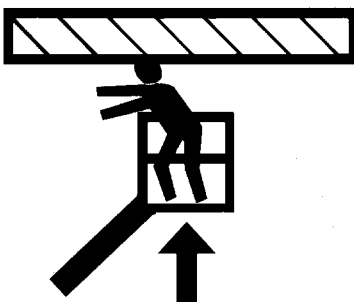

- WATCH FOR OBSTRUCTIONS AROUND MACHINE AND OVERHEAD WHEN DRIVING.

- ALWAYS POSITION BOOM OVER REAR (DRIVE) AXLE IN LINE WITH DIRECTION OF TRAVEL. REMEMBER, IF BOOM IS OVER FRONT (STEER) AXLE, DIRECTION OF STEER AND DRIVE MOVEMENT WILL BE OPPOSITE FROM NORMAL OPERATION.

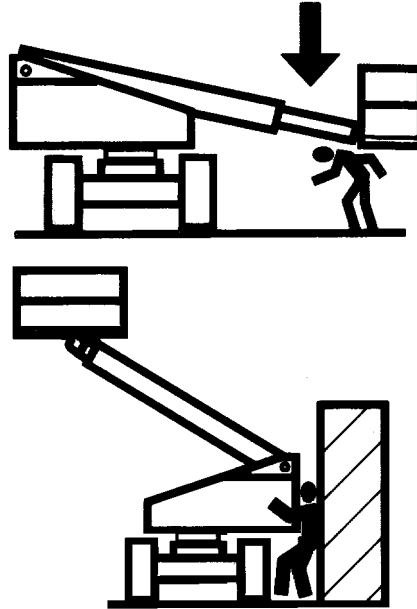

- DO NOT USE DRIVE FUNCTION TO POSITION PLATFORM CLOSE TO OBSTACLES. USE BOOM FUNCTION INSTEAD.
- WHEN DRIVING IN HIGH SPEED, SWITCH TO LOW SPEED BEFORE STOPPING. TRAVEL GRADES IN LOW DRIVE, HIGH ENGINE ONLY.
- DO NOT USE HIGH SPEED DRIVE WHEN IN RESTRICTED OR CLOSE QUARTERS, OR WHEN DRIVING IN REVERSE.
- BE AWARE OF STOPPING DISTANCES WHEN TRAVELING IN HIGH AND LOW SPEEDS.
- ALWAYS POST A LOOKOUT AND SOUND HORN WHEN DRIVING IN AREAS WHERE VISION IS OBSTRUCTED.
- KEEP NON-OPERATING PERSONNEL AT LEAST 2 M (6 FEET) AWAY FROM MACHINE DURING DRIVING OPERATIONS.

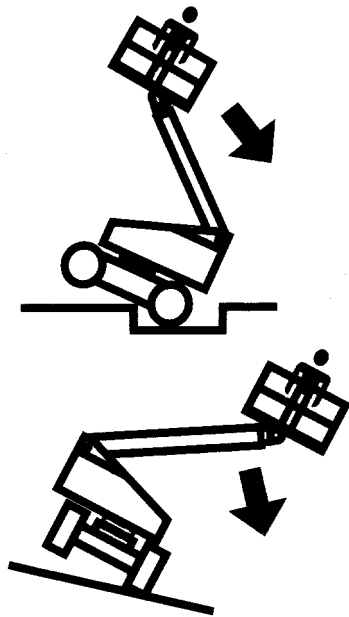

- CHECK TRAVEL PATH FOR PERSONS, DEPRESSIONS, HOLES, BUMPS, DROP-OFFS, OBSTRUCTIONS, DEBRIS, AND COVERINGS WHICH MAY CONCEAL HOLES AND OTHER HAZARDS.
- TRAVEL IS PERMITTED ON GRADES NO GREATER THAN THOSE INDICATED ON THE SERIAL NUMBER PLATE.
- DO NOT DRIVE ON SIDESLOPES WHICH EXCEED 5°.
- DO NOT TRAVEL ON SOFT OR UNEVEN SURFACES, AS TIPPING WILL OCCUR.
- DO NOT DRIVE MACHINE NEAR PITS, LOADING DOCKS OR OTHER DROP-OFFS.

1.6 OPERATION.

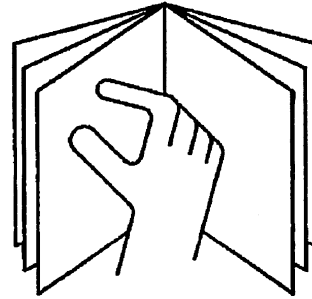

- READ YOUR MANUAL. UNDERSTAND WHAT YOU'VE READ - THEN BEGIN OPERATIONS.

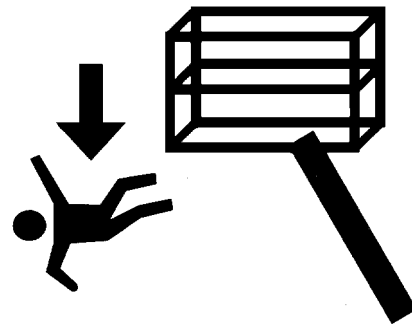

- PRIOR TO ENTERING AND EXITING PLATFORM AT GROUND LEVEL, FULLY LOWER THE BOOM. EXTEND BOOM UNTIL END OF FLY BOOM CONTACTS GROUND. WITH BOOM LIFT IN THIS CONFIGURATION, ENTER AND/OR EXIT PLATFORM THROUGH GATE OPENING.
- JLG RECOMMENDS ALL PERSONS IN THE PLATFORM TO WEAR LANYARDS WITH AN APPROVED FALL PROTECTION DEVICE. SECURE LANYARD TO DESIGNATED LANYARD ATTACH POINT ON PLATFORM. KEEP GATE CLOSED AT ALL TIMES.
- TO AVOID FALLING - USE EXTREME CAUTION WHEN ENTERING OR LEAVING PLATFORM ABOVE GROUND. ENTER OR EXIT THRU GATE ONLY. PLATFORM FLOOR MUST BE WITHIN 30CM (1 FOOT) OF ADJACENT - SAFE AND SECURE - STRUCTURE. ALLOW FOR PLATFORM VERTICAL MOVEMENT AS WEIGHT IS TRANSFERRED TO OR FROM PLATFORM.

SECTION 1 - SAFETY PRECAUTIONS

- TRANSFERS BETWEEN A STRUCTURE AND THE AERIAL PLATFORM EXPOSE OPERATORS TO FALL HAZARDS. THIS PRACTICE SHOULD BE DISCOURAGED WHEREVER POSSIBLE. WHERE TRANSFER MUST BE ACCOMPLISHED TO PERFORM THE JOB TWO LANYARDS WITH AN APPROVED FALL PROTECTION DEVICE WILL BE USED. ONE LANYARD SHOULD BE ATTACHED TO THE AERIAL PLATFORM. THE OTHER TO THE STRUCTURE. THE LANYARD THAT IS ATTACHED TO THE AERIAL PLATFORM SHOULD NOT BE DISCONNECTED UNTIL SUCH TIME AS THE TRANSFER TO THE STRUCTURE IS COMPLETE. OTHERWISE, DO NOT STEP OUTSIDE OF PLATFORM.
- DO NOT ADD NOTICE BOARDS OR SIMILAR ITEMS TO THE PLATFORM. ADDITION OF SUCH ITEMS INCREASES THE EXPOSED WIND AREA OF THE MACHINE.
- NEVER POSITION LADDERS, STEPS, OR SIMILAR ITEMS ON UNIT TO PROVIDE ADDITIONAL REACH FOR ANY PURPOSE.
- WHEN RIDING IN OR WORKING FROM PLATFORM, BOTH FEET MUST BE FIRMLY POSITIONED ON THE FLOOR.
- KEEP OIL, MUD AND SLIPPERY SUBSTANCES CLEANED FROM FOOTWEAR AND PLATFORM FLOOR.
- NEVER "WALK" THE BOOM TO GAIN ACCESS TO OR LEAVE PLATFORM.
- NEVER PLACE HANDS OR ARMS IN TOWER BOOM OR UPRIGHT MECHANISM.
- KEEP ALL NON-OPERATING PERSONNEL AT LEAST 2 METERS (6 FEET) AWAY FROM THE MACHINE AT ALL TIMES.

- IF PLATFORM OR BOOM IS CAUGHT SO THAT ONE OR MORE WHEELS ARE OFF THE FLOOR, ALL PERSONNEL MUST BE REMOVED FROM PLATFORM BEFORE ATTEMPTING TO FREE MACHINE. USE CRANES, FORKLIFT TRUCKS OR OTHER EQUIPMENT TO REMOVE PERSONNEL AND STABILIZE MACHINE MOTION, IF NECESSARY.

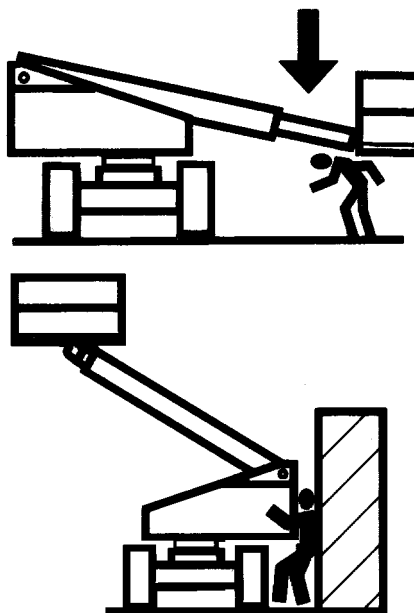

- THE OPERATOR IS RESPONSIBLE TO AVOID OPERATING MACHINE OVER GROUND PERSONNEL AND TO WARN THEM NOT TO WORK, WALK OR STAND UNDER A RAISED BOOM OR PLATFORM. POSITION BARRICADES ON FLOOR IF NECESSARY.

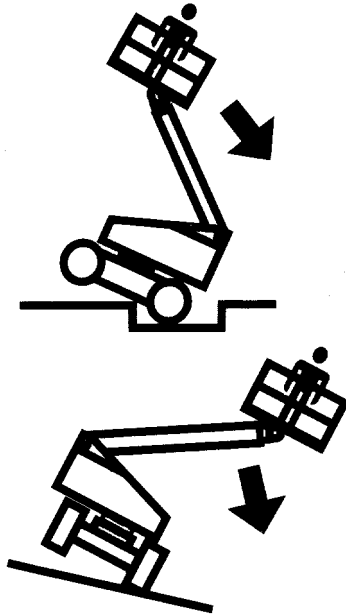

- ENSURE MACHINE IS POSITIONED ON A FIRM, LEVEL AND UNIFORM SUPPORTING SURFACE BEFORE RAISING OR EXTENDING BOOM.

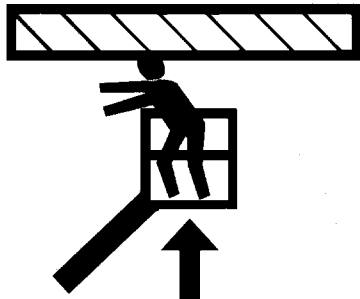

- CHECK CLEARANCES ABOVE, ON SIDES AND BOTTOM OF PLATFORM WHEN RAISING, LOWERING, SWINGING, AND TELESCOPING BOOM.
- EXERCISE EXTREME CAUTION AT ALL TIMES TO PREVENT OBSTACLES FROM STRIKING OR INTER-

FERING WITH OPERATING CONTROLS AND PERSONS IN PLATFORM.

- ENSURE THAT OPERATORS OF OTHER OVERHEAD AND FLOOR MACHINES ARE AWARE OF THE AERIAL PLATFORMS PRESENCE. DISCONNECT POWER TO OVERHEAD CRANES. POSITION BARRICADES ON FLOOR IF NECESSARY.
- NEVER "SLAM" A CONTROL SWITCH OR LEVER THROUGH NEUTRAL TO THE OPPOSITE DIRECTION. ALWAYS RETURN SWITCH TO NEUTRAL AND STOP; THEN MOVE SWITCH TO THE DESIRED POSITION. OPERATE LEVERS WITH SLOW, EVEN PRESSURE.
- DO NOT CARRY MATERIALS ON PLATFORM RAILING UNLESS APPROVED BY JLG INDUSTRIES INC.
- NEVER PUSH OR PULL THE MACHINE OR OTHER OBJECTS BY TELESCOPING THE BOOM.
- NEVER USE BOOM FOR ANY PURPOSE OTHER THAN POSITIONING PERSONNEL, THEIR TOOLS AND EQUIPMENT.
- NEVER EXCEED MANUFACTURERS RATED PLATFORM CAPACITY - REFER TO CAPACITY DECAL ON MACHINE. DISTRIBUTE LOADS EVENLY ON PLATFORM FLOOR.
- NEVER OPERATE A MALFUNCTIONING MACHINE. IF A MALFUNCTION OCCURS, SHUT DOWN THE MACHINE, RED TAG IT, AND NOTIFY PROPER AUTHORITIES.
- DO NOT REMOVE, MODIFY, OR DISABLE FOOT-SWITCH BY BLOCKING OR ANY OTHER MEANS.
- DO NOT ASSIST A STUCK OR DISABLED MACHINE BY PUSHING OR PULLING EXCEPT BY PULLING AT CHASSIS TIE-DOWN LUGS.
- NEVER ATTEMPT USING BOOM AS A CRANE. STRUCTURAL DAMAGE OR TIPPING MAY OCCUR.
- STOW BOOM AND SHUT OFF ALL POWER BEFORE LEAVING MACHINE.
- NO STUNT DRIVING OR HORSEPLAY IS PERMITTED.

SECTION 1 - SAFETY PRECAUTIONS

- NEVER ATTEMPT TO FREE A MACHINE STUCK IN SOFT GROUND OR ASSIST A MACHINE UP A STEEP HILL OR RAMP BY USING BOOM "LIFT", "TELESCOPE", OR "SWING" FUNCTIONS.
- NEVER ATTACH WIRE, CABLE, OR ANY SIMILAR ITEMS TO PLATFORM.
- DO NOT PLACE BOOM OR PLATFORM AGAINST ANY STRUCTURE TO STEADY PLATFORM OR SUPPORT STRUCTURES.
- DO NOT USE THE LIFT, SWING, OR TELESCOPE FUNCTIONS FOR THE BOOM, TO MOVE EITHER THE MACHINE OR OTHER OBJECTS.
- HYDRAULIC CYLINDERS SHOULD NEVER BE LEFT FULLY EXTENDED OR RETRACTED FOR ANY LENGTH OF TIME. ALWAYS "BUMP" CONTROL IN OPPOSITE DIRECTION SLIGHTLY WHEN FUNCTION BEING USED REACHES END OF TRAVEL. THIS APPLIES TO MACHINES IN OPERATION OR IN STOWED MODE.
- DO NOT OPERATE ANY MACHINE ON WHICH DANGER, WARNING, CAUTION OR INSTRUCTION PLACARDS OR DECALS ARE MISSING OR ILLEGIBLE.

- MACHINE MUST ALWAYS BE SHUT DOWN WHEN REFUELING. NO SMOKING IS MANDATORY. NEVER REFUEL DURING AN ELECTRICAL STORM. ENSURE THAT FUEL CAP IS CLOSED AND SECURE AT ALL OTHER TIMES.

1.7 TOWING AND HAULING

- DO NOT TOW A MACHINE EXCEPT IN AN EMERGENCY. SEE SECTION 6 FOR EMERGENCY TOWING PROCEDURES.
- LOCK TURNTABLE BEFORE TRAVELING LONG DISTANCES OR BEFORE HAULING MACHINE ON A TRUCK OR TRAILER.

SECTION 2. PREPARATION AND INSPECTION

2.1 GENERAL

This section provides the necessary information needed by those personnel that are responsible to place the machine in operation readiness, and lists checks that are performed prior to use of the machine. It is important that the information contained in this section be read and understood before any attempt is made to operate the machine. Ensure that all the necessary inspections have been completed successfully before placing the machine into service. These procedures will aid in obtaining maximum service life and safe operation.

IMPORTANT

SINCE THE MACHINE MANUFACTURER HAS NO DIRECT CONTROL OVER THE FIELD INSPECTION AND MAINTENANCE, SAFETY IS THE RESPONSIBILITY OF THE OWNER/OPERATOR.

2.2 PREPARATION FOR USE

Before a new machine is put into operation it must be carefully inspected for any evidence of damage resulting from shipment and inspected periodically thereafter, as outlined in Delivery and Frequent Inspection (see section 2-3). During initial start-up and run, the unit should be thoroughly checked for hydraulic leaks. A check of all components should be made to assure their security.

All preparation necessary to place the machine in operation readiness status is the responsibility of management personnel. Preparation requires good common sense, (i.e. telescope works smoothly and brakes operate properly) coupled with a series of visual inspections. The mandatory requirements are given in the Daily Walk Around Inspection (see section 2-4).

It should be assured that the items appearing in the Delivery and Frequent Inspection and Functional Check are complied with prior to putting the machine into service.

2.3 DELIVERY AND FREQUENT INSPECTION

NOTE: This machine requires periodic safety and maintenance inspections by an authorized JLG Dealer.

NOTE: An annual inspection shall be performed on the aerial platform no later than thirteen (13) months from the date of the prior annual inspection. The inspection shall be performed by person(s) qualified as a mechanic on the specific make and model of the aerial platform.

The following checklist provides a systematic inspection to assist in detecting defective, damaged, or improperly installed parts. The checklist denotes the items to be inspected and conditions to examine.

Frequent inspection shall be performed every 3 months or 150 hours whichever comes first, or more often when required by environment, severity, and frequency of usage.

This inspection checklist is also applicable and must be followed for all machines that have been in storage or for all machines that will be exposed to harsh or changing climates.

These checks are also to be performed after maintenance has been performed on the machine.

Chassis

1. Check front tires and wheel assemblies for loose or worn spindles, components and hardware for security, tires for wear and damage.
2. Check steering assembly for loose or bent tie rod, cylinder and hydraulic lines for leaks and security, and hardware for proper installation.
3. If equipped with 4WD, check drive hubs, hydraulic motors, brakes and hydraulic lines for damage and leaks.
4. Check rear tires and wheel assemblies for security, tires for wear and damage.
5. Check drive hubs, hydraulic motors, brakes and hydraulic lines for damage and leaks.
6. Check oil level in drive hub by removing pipe plug on side and feeling for oil level. (Contact Service Personnel for assistance if needed).

NOTE: Torque hubs should be one-half full of lubricant.

7. Check oscillating axle (if equipped) for loose, missing and worn parts, pivot pin and lockout cylinder pins for security, lockout cylinders and hydraulic hoses for damage and leaks.

SECTION 2 - PREPARATION AND INSPECTION

Turntable

1. Check turntable for damage, loose or missing parts, and security. Check swing drive and brake for damage, loose or missing parts, hydraulic lines and component housings for evidence of leakage; worm gear for proper mesh with swing gear.
2. Check swing bearing for damage, wear, lubrication and loose or missing bearing bolts.
3. Check solenoid valves and hydraulic lines for damage, leakage, security and electrical connections for tightness and evidence of corrosion.
4. Check ground controls for damage, loose or missing parts, security, electrical connections for evidence of corrosion and tightness and wiring for insulation damage. Assure that all switches function properly.
5. Check battery for damage, loose or missing vent caps, electrical connections for tightness, and evidence of corrosion, hold-down brackets for tightness, and electrolyte for proper water level. Add only clean distilled water to battery.
6. Check engine tray pivot assembly for damage, loose or missing parts, and security.
7. Check engine and accessories for damage, loose or missing parts, leakage and security. Check throttle solenoid and linkage for damage, electrical connections for tightness, and evidence of corrosion and wiring for insulation damage.
8. Check fuel lines for damage, leakage and security.
9. Check all access doors for damage, proper operation of latches, props and security.
10. Check fuel tank for damage, leakage and filler cap for security.
11. Check hydraulic reservoir and hydraulic lines for damage, leakage and security.

NOTE: JLG recommends replacing the hydraulic filter element after the first 50 hours of operation and then every 300 hours thereafter, unless system indicator require earlier replacement.

12. Check all pin and shaft retaining hardware for security and wear.
13. Check all electrical cables for defects, damage, loose or corroded connections.

Boom

1. Check Lower Boom and leveling link for damage, missing parts and security.
2. Check all pin and shaft retaining hardware for security and wear.
3. Check hydraulic lines and electrical cable for damage, missing parts and security.
4. Check limit switch connections and plunger for corrosion and security.
5. Check Lower Upright, cross pins and hydraulic lines for damage, wear, lubrication, leakage and security.
6. Check Lower Upright for damage, wear, lubrication and security.
7. Check hydraulic lines mounted on upright for damage, leakage and security.
8. Check boom pivot bushings for wear.
9. Check boom lift cylinder and hydraulic lines for damage, leakage and security. Check lift cylinder cross pins for damage, wear and security.
10. Check all pin and shaft retaining hardware for security and wear.
11. Check Upper Upright, cross pins and hydraulic lines for damage, wear, lubrication, leakage and security.
12. Check Upper Upright for damage, wear, lubrication and security.
13. Check hydraulic lines mounted on upright for damage, leakage and security.
14. Check Upper Boom Lift Cylinder and cross pins and hydraulic lines for damage, wear, lubrication, leakage and security.

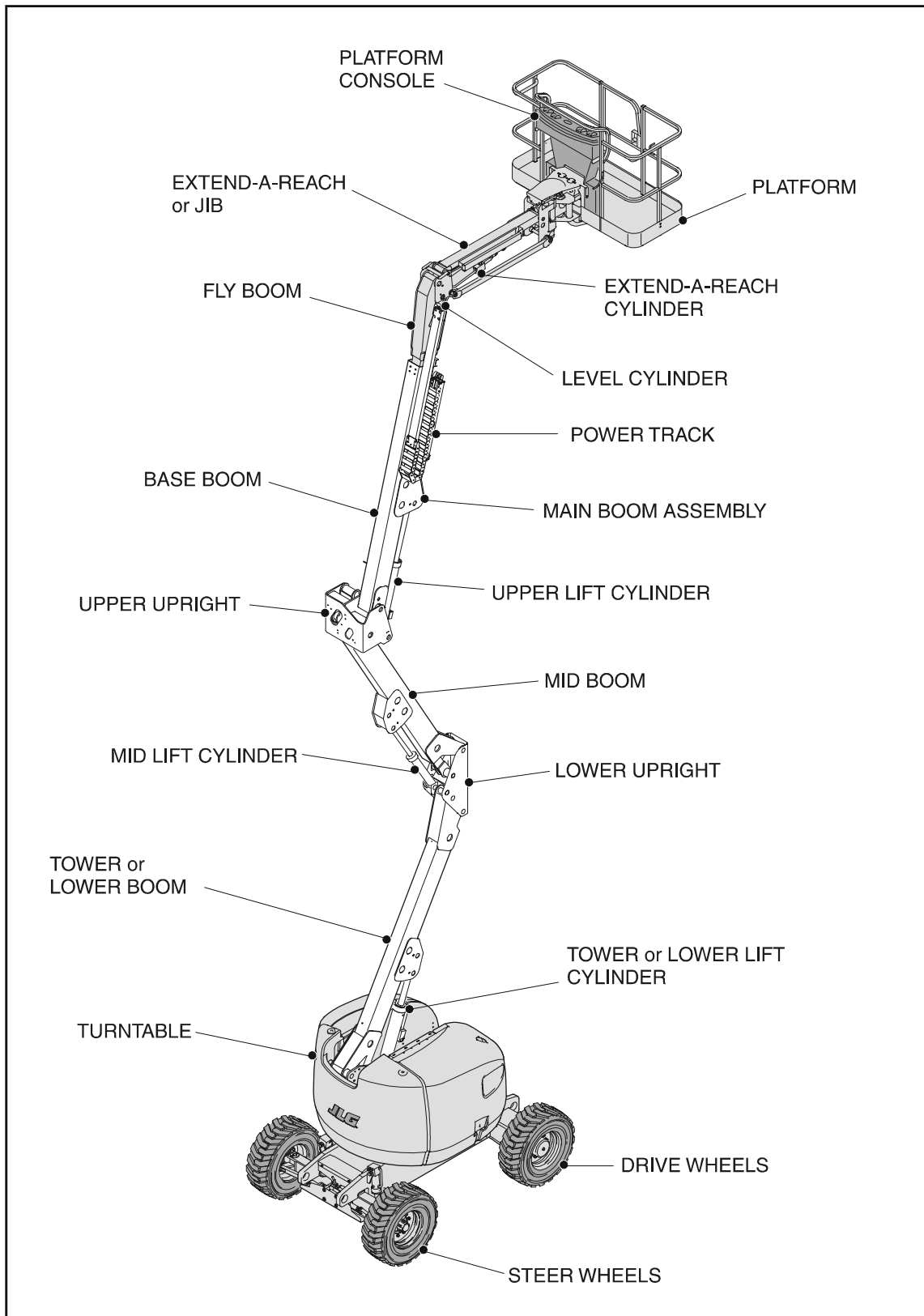

Figure 2-1. Machine Nomenclature

SECTION 2 - PREPARATION AND INSPECTION

15. Check Upper Boom pivot pin for damage, wear, lubrication and security.
16. Check Upper Boom for damage, missing parts and security.
17. Check Upper Boom wear pads for damage, missing parts and security.
18. Check Upper Boom telescope cylinder, cross pins and hydraulic lines for damage, wear, lubrication, leakage and security.
19. Check Platform Leveling Cylinder, cross pins and hydraulic lines for damage, wear, lubrication, leakage and security.

Platform

1. Check platform and control console for damage, loose or missing parts, and security.
 2. Check control switches and levers for damage, loose or missing parts and security. Assure that levers function properly.
 3. Check control switches, levers and electrical connections for tightness and evidence of corrosion, and wiring for defects and chafing damage. Assure that switches function properly.
4. Check access gate hinges, stop, and latch for proper operation, damage and security.
 5. Check platform rotator mechanism for proper operation, damage, security. Check hydraulic lines for leakage, damage and security.

NOTE: Check all DANGER, WARNING, CAUTION and INSTRUCTION placards for legibility and security on the entire machine.

Torque Requirements

The Torque Chart (Figure 2-6.) consists of standard torque values based on bolt diameter and grade, also specifying dry and wet torque values in accordance with recommended shop practices. This chart is provided as an aid to the operator in the event he/she notices a condition that requires prompt attention during the walk-around inspection or during operation, until the proper service personnel can be notified. The Service and Maintenance manual provides specific torque values and periodic maintenance procedures with a listing of individual components. Utilizing this Torque Chart in conjunction with the preventive maintenance section in the Service and Maintenance manual will enhance safety, reliability, and performance of the machine.

2.4 DAILY WALK-AROUND INSPECTION

It is the operators responsibility to inspect the machine before the start of each workday. It is recommended that each operator inspect the machine before operation, even if the machine has already been put into service under another operator. This Daily Walk-Around Inspection is the preferred method of inspection.

These checks are also to be performed after maintenance has been performed on the machine.

In addition to the Daily Walk-Around Inspection, be sure to include the following as part of the daily inspection:

1. Overall cleanliness.

Check all standing surfaces for oil, fuel and hydraulic oil spillage and foreign objects. Ensure overall cleanliness.

2. Placards.

Keep all information and operating placards clean and unobstructed. Cover when spray painting or shot blasting to protect legibility.

3. Operator's and Safety Manual.

Ensure a copy of this manual and the ANSI A92.5-1992 Responsibilities, are enclosed in the manual storage box.

4. Machine Log.

Ensure a machine operating record or log is kept, check to see that it is current and that no entries

have been left uncleared, leaving machine in an unsafe condition for operation.

5. Start each day with a full fuel tank.

! WARNING

TO AVOID INJURY, DO NOT OPERATE A MACHINE UNTIL ALL MALFUNCTIONS HAVE BEEN CORRECTED. USE OF A MALFUNCTIONING MACHINE IS A SAFETY VIOLATION.

TO AVOID POSSIBLE INJURY, BE SURE MACHINE POWER IS "OFF" DURING WALK-AROUND INSPECTION.

NOTE: Check boom limit switches on upright for proper operation and security, both visually and manually. The lower switch cuts out drive speed when the lower boom is above horizontal. The upper switch cuts out drive speed when the upper boom is above horizontal. Only creep drive speed will continue to function.

6. Check platform footswitch for proper operation. Switch must be released to start engine and depressed to operate machine.

7. Check that drive brakes hold when machine is driven up a grade not greater than specified on the serial number placard and stopped.

NOTE: On new machines, those recently overhauled, or after changing hydraulic oil, operate all systems a minimum of two complete cycles and recheck oil level in reservoir.

8. Assure that all items requiring lubrication are serviced. Refer to Figure 2-5., Lubrication Diagram for specific requirements.

SECTION 2 - PREPARATION AND INSPECTION

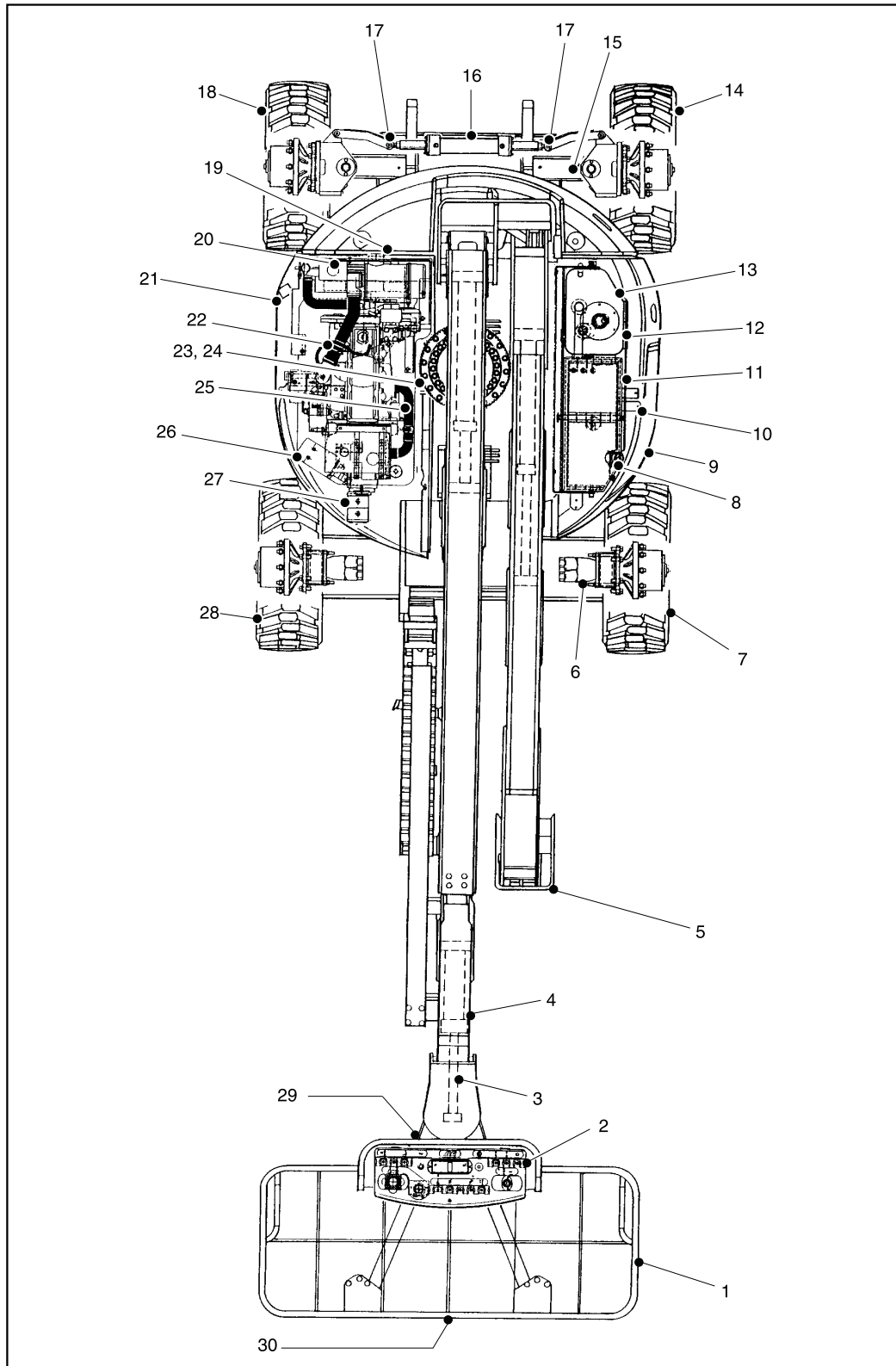

Figure 2-2. Daily Walk-Around Inspection - Sheet 1 of 3

GENERAL

Begin the "Walk-Around Inspection" at Item 1, as noted on the diagram. Continue to the right (counterclockwise viewed from top) checking each item in sequence for the conditions listed in the Walk-Around Inspection Checklist.

⚠ WARNING

TO AVOID INJURY, DO NOT OPERATE A MACHINE UNTIL ALL MALFUNCTIONS HAVE BEEN CORRECTED. USE OF A MALFUNCTIONING MACHINE IS A SAFETY VIOLATION. TO AVOID POSSIBLE INJURY, BE SURE MACHINE POWER IS OFF DURING WALK-AROUND INSPECTION.

NOTE: *Do not overlook visual inspection of chassis underside. Checking this area often results in discovery of conditions which could cause extensive machine damage.*

1. Platform Assembly - No loose or missing parts, no visible damage. Lockbolts in place. Footswitch in good working order, not modified, disabled or blocked.
2. Platform Control Console - Switches and levers return to neutral and are properly secured, no loose or missing parts, no visible damage, decals/placards secure and legible, control marking legible.
3. Slave Cylinder - No visible damage; pivot pins secure hydraulic hoses undamaged, not leaking.
4. Boom Sections/Uprights/Lift Cylinders and Master Cylinder - No visible damage; pivot pins secure; hydraulic hoses undamaged, not leaking. Uprights in vertical position.
5. Horizontal Limit Switches - Switches operable; no visible damage.
6. Drive Motor, Brake, and Hub - No visible damage; no evidence of leakage.
7. Wheel/Tire Assembly, Right Rear - Properly secured, no loose or missing lug nuts, no visible damage.
8. Hydraulic Filter - Housing secure no visible damage; no evidence of leakage.
9. Hood, Right Side - Properly secured; no loose or missing parts.
10. Control Valve - No loose or missing parts; evidence of leakage; unsupported wires or hoses; damaged or broken wires.
11. Fuel Supply - Filler cap secure, no visible damage to the tank or evidence of leaks.
12. Ground Controls - Switches operable, no visible damage, decals secure and legible.
13. Hydraulic Oil Supply - Recommended oil level sight gauge. (Check level with cold oil, systems shut down, machine in stowed position) Cap in place and secure.
14. Wheel/Tire Assembly, Right Front - Properly secured, no loose or missing lug nuts, no visible damage.
15. Oscillating Axle - No loose or missing hardware; no visible damage.
16. Steer Cylinder - Properly secured; no visible damage or signs of leakage; evidence of proper lubrication.
17. Tie Rod Ends and Steering Spindles - No loose or missing parts; no visible damage.
18. Wheel/Tire Assembly, Left Front - Properly secured, no loose or missing lug nuts, no visible damage.
19. Battery - Proper electrolyte levels; cables tight, no visible damage or corrosion.
20. Engine Air Filter - No loose or missing parts; no visible damage; element clean.
21. Hood, Right Side - Properly secured; no loose or missing parts.
22. Engine Oil Supply - Full mark on dipstick; filler cap secure.

Figure 2-3. Daily Walk-Around Inspection - Sheet 2 of 3

SECTION 2 - PREPARATION AND INSPECTION

- | | |
|---|---|
| 23. Turntable Bearing - No loose or missing hardware; no visible; evidence of proper lubrication; no evidence of loose bolts or looseness between bearing or structure. | 27. Hydraulic Pump - No loose or missing parts, no evidence of leakage. |
| 24. Swing Motor and Worm Gear - No loose or missing hardware; no visible damage; evidence of proper lubrication. | 28. Wheel/Tire Assembly, Left Rear - Properly secured, no loose or missing lug nuts, no visible damage. |
| 25. Muffler and Exhaust System - Properly secured, no evidence of leakage. | 29. Rotator Cylinders - No visible damage; cylinder pins secure; hydraulic hoses undamaged and not leaking. |
| 26. Auxiliary Power Pump - No loose or missing parts, no evidence of leakage, no damaged wires. | 30. Platform Gate - Latch, stop, and hinges or drop bar in working condition and properly secured; no loose or missing parts. |

Figure 2-4. Daily Walk-Around Inspection - Sheet 3 of 3

2.5 DAILY FUNCTIONAL CHECK

A functional check of all systems must be performed, once the walk-around inspection is complete, in an area free of overhead and ground level obstructions. First, using the ground controls, check all functions controlled by the ground controls. Next, using the platform controls, check all functions controlled by the platform controls.

⚠ WARNING

TO AVOID SERIOUS INJURY, DO NOT OPERATE MACHINE IF ANY CONTROL LEVERS OR TOGGLE SWITCHES CONTROLLING PLATFORM MOVEMENTS DO NOT RETURN TO THE OFF OR NEUTRAL POSITION WHEN RELEASED.

⚠ WARNING

TO AVOID A COLLISION AND INJURY IF PLATFORM DOES NOT STOP WHEN A CONTROL SWITCH OR LEVER IS RELEASED, REMOVE FOOT FROM FOOTSWITCH OR USE EMERGENCY STOP TO STOP THE MACHINE.

NOTE: *When the boom is raised above horizontal, high drive speed is cut out.*

1. Check boom horizontal limit switches to see that they are operable and not damaged. Raise and lower Lower Boom. Check for smooth operation. Check Boom Upright tilting for proper synchronization. If the upright is tilted or the boom will not fully lower, refer to the Boom Synchronizing Procedure in Section 3.

NOTE: *Perform checks from ground controls first, then from platform controls.*

2. Raise, extend, retract and lower Upper Boom. Check for smooth operation.
3. Telescope boom IN and OUT several cycles at various degrees of elevation lengths. Check for smooth telescope operation.
4. Swing turntable to LEFT and RIGHT a minimum of 45 degrees. Check for smooth motion.
5. With the aid of an assistant to monitor the CHASSIS OUT OF LEVEL indicator light on the platform console, manually activate the indicator light by compressing one of the three tilt indicator mounting

springs. If the light does not illuminate, shut down machine and contact a qualified service technician before continuing operation.

6. Check that platform self-leveling system functions properly during raising and lowering of boom.
7. Check rotator for smooth operation and assure platform will rotate 75 degrees in both directions from centerline of boom.
8. Drive forward and reverse; check for proper operation.
9. Steer left and right; check for proper operation.
10. Footswitch.

⚠ IMPORTANT

FOOTSWITCH MUST BE ADJUSTED SO THAT FUNCTIONS WILL OPERATE WHEN PEDAL IS APPROXIMATELY AT ITS CENTER OF TRAVEL. IF SWITCH OPERATES WITHIN LAST 1/4" OF TRAVEL, TOP OR BOTTOM, IT SHOULD BE ADJUSTED.

- a. Activate hydraulic system, by depressing footswitch. Operate Telescope and hold control. Remove foot from footswitch, motion should stop. If it does not, shut down machine and contact a certified JLG service technician.
 - b. With footswitch depressed, operate Lift and hold control. Remove foot from footswitch, motion should stop. If it does not, shut down machine and contact a certified JLG service technician.
 - c. With engine power shut down, depress the footswitch. Attempt to start engine. Engine should not attempt to start when footswitch is depressed. If starter engages or engine turns over, shut down machine and contact a certified JLG service technician.
11. Auxiliary Power.

Operate each function control switch (e.g. Tele, Lift, and Swing) to assure that they function in both directions using auxiliary power instead of engine power.

12. Ground Controls.

Place Ground/Platform Select switch to Ground. Start engine. Platform controls should not operate.

2.6 BATTERY MAINTENANCE

⚠ WARNING

TO AVOID INJURY FROM AN EXPLOSION, DO NOT SMOKE OR ALLOW SPARKS OR A FLAME NEAR BATTERY DURING SERVICING.

⚠ WARNING

ALWAYS WEAR EYE PROTECTION WHEN SERVICING BATTERIES.

1. The battery is maintenance free except for occasional battery terminal cleaning, as noted in the following.

2. Remove battery cables from each battery post one at a time, negative first. Clean cables with acid neutralizing solution (e.g. baking soda and water or ammonia) and wire brush. Replace cables and/or cable clamp bolts as required.
3. Clean battery post with wire brush then re-connect cable to post. Coat non-contact surfaces with mineral grease or petroleum jelly (Vaseline).
4. When all cables and terminal posts have been cleaned, ensure all cables are properly positioned and are not pinched. Close battery compartment cover.

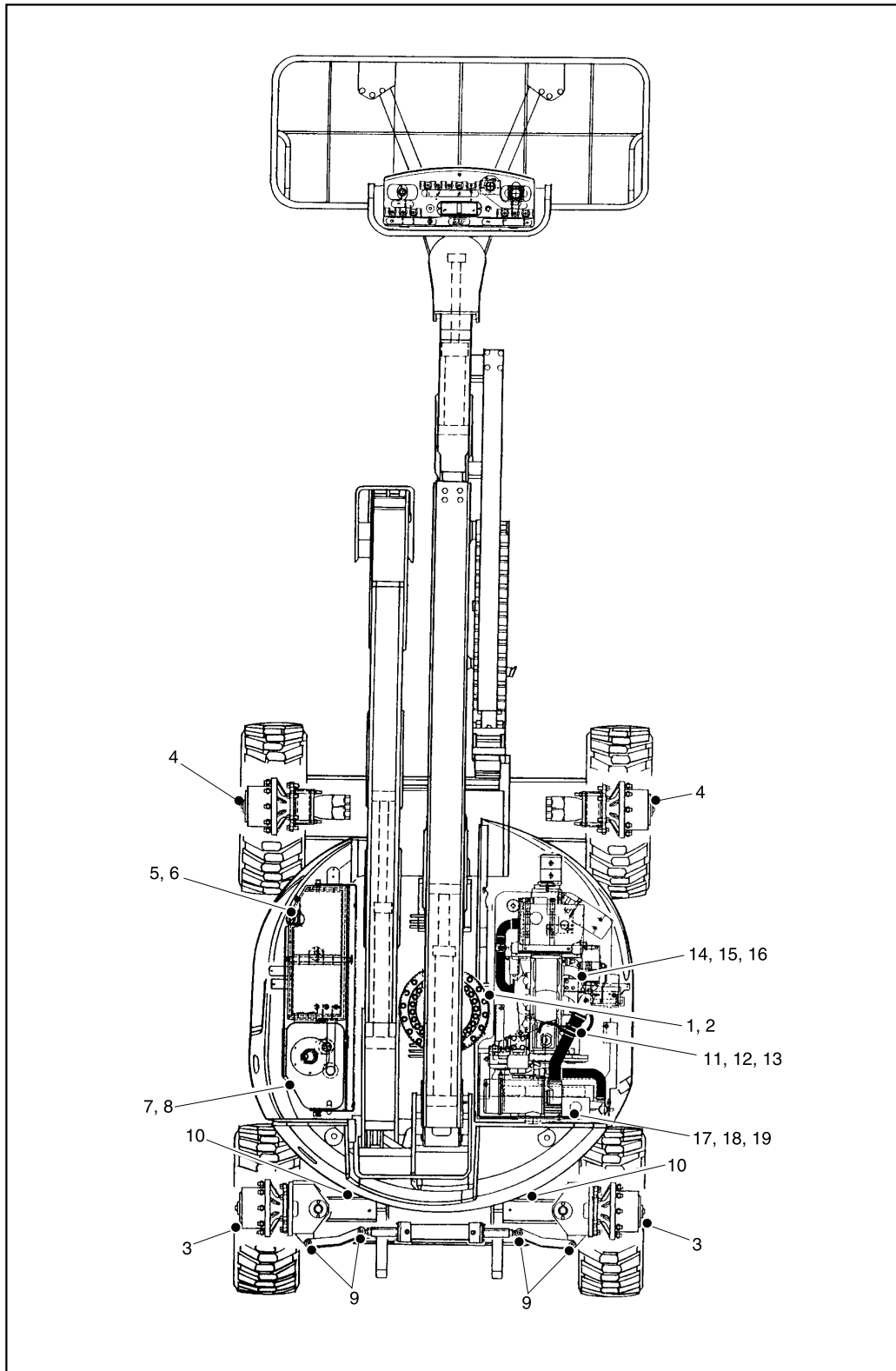

Figure 2-5. Lubrication Diagram

SECTION 2 - PREPARATION AND INSPECTION

Table 2-1. Lubrication Chart

	Components	Number/Type Lube Points	Capacity	Lube	Interval		Hours		Comments
					3 Months 150 hrs	6 Months 300 hrs	1 Year 600 hrs	2 Years 1200 hrs	
Lubrication									
1	Swing Bearing - Internal Ball Bearing	2 Grease Fitting	A/R	MPG	X				
2a	Swing Bearing - Teeth	Spray On	A/R	OGL	X				More frequent lubrication intervals may be required.
2b	End Bearings - Worm Gear*	2	A/R	MPG				X	Remove grease fittings and install plugs after greasing.
3	Wheel Bearings (2WD Only)	Repack	A/R	MPG				X	
4	Wheel Drive Hub	Level/Fill Plug	0.5 liters (1/2 full)	EPGL				X	Change after first 150 hours then every 1200 hours of operation.
5	Hydraulic Return Filter	N/A	N/A	N/A		X			Change after first 50 hours and every 300 hours thereafter or as indicated by condition indicator.
6	Hydraulic Charge Filter	N/A	N/A	N/A		X			Change after first 50 hours and every 300 hours thereafter or as indicated by condition indicator.
7	Hydraulic Oil	Fill Cap	116 liters Tank 124 liters System	HO				X	Check level daily. Change every 1200 hours.
8	Suction Strainers (In Tank)	2	N/A	N/A				X	Remove and clean at time of hydraulic oil change.
9	Steer Cylinder	4	A/R	MPG	X				
10	Oscillation Cylinders	2	A/R	MPG	X				
Engines									
11	Oil Change w/Filter - Ford	Fill Cap/Spin-on Element	5 Quarts (4.7L)	EO	X				Check level daily; change every 150 hours. Adjust final oil level by mark on dipstick.
12	Oil Change w/Filter - Deutz	Fill Cap/Spin-on Element	6 liters crankcase **4.5 liters cooler	EO	X				Check level daily; change every 600 hours. Adjust final oil level by mark on dipstick.
13	Oil Change w/Filter - Isuzu	Fill Cap/Spin-on Element	5.6 liters crankcase 6.1 liters w/cooler	EO	X				Check level daily; change every 150 hours. Adjust final oil level by mark on dipstick.
14	Fuel Filter - Ford	Replaceable Element	N/A	N/A				X	
15	Fuel Filter - Deutz	Replaceable Element	N/A	N/A				X	
16	Fuel Filter - Isuzu	Replaceable Element	N/A	N/A				X	

SECTION 2 - PREPARATION AND INSPECTION

Table 2-1. Lubrication Chart

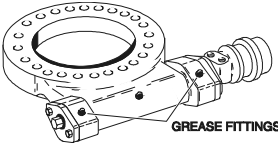
	Components	Number/Type Lube Points	Capacity	Lube	Interval		Hours		Comments
					3 Months 150 hrs	6 Months 300 hrs	1 Year 600 hrs	2 Years 1200 hrs	
17	Air Filter - Ford	Replaceable Element	N/A	N/A		X			Or as indicated by condition indicator
18	Air Filter - Deutz	Replaceable Element	N/A	N/A		X			Or as indicated by condition indicator
19	Air Filter - Isuzu	Replaceable Element	N/A	N/A		X			Or as indicated by condition indicator
NOTES:								KEY TO LUBRICANTS	
Lubrication intervals are based on machine operation under normal conditions. For machines used in multi shift operations and/or exposed to hostile environments or conditions, lubrication frequencies must be increased accordingly.								EO EPGL HO MPG OGL	Engine Oil Extreme Pressure Gear Lube Hydraulic Fluid (Mobil DTE-11M) Multi-Purpose Grease Open Gear Lubricant - Mobilnac 375 or equivalent
<p>* If necessary install grease fittings into worm gear housing and grease bearings.</p> <div style="display: flex; align-items: center; justify-content: center;"> <div style="text-align: center; margin-right: 20px;">  <p>CAUTION</p> </div> <div style="text-align: center;">  </div> </div> <p>DO NOT OVERGREASE BEARINGS. OVERGREASING BEARINGS WILL RESULT IN BLOWING OUTER SEAL IN HOUSING.</p>									
<p>**When changing oil in the Deutz oil cooled engine, drain both the crankcase and the cooler. When refilling it is acceptable to overfill crankcase (10.5 L, capacity of both crankcase and cooler combined). Start engine, allow the engine to run until the thermostat opens (approximately 105 degrees C) cooler will fill up within minutes; shut down and wait for approximately two minutes. Check oil level, fill oil to max marking on dipstick.</p>									

SIZE	THD	BOLT DIA. (CM)	THREAD STRESS AREA (SQ. CM)	VALUES FOR ZINC PLATED BOLTS ONLY												UNPLATED CAP SCREWS
				SAE GRADE 5 BOLTS & GRADE 2 NUTS				SAE GRADE 8 BOLTS & GRADE 8 NUTS				UNBRAKO 1960 SERIES SOCKET HEAD CAP SCREW WITH LOC-WEL PATCH				
				CLAMP LOAD (KG)		TORQUE		CLAMP LOAD (KG)		TORQUE		CLAMP LOAD (KG)		TORQUE		
				(DRY OR LOC. 263)	(LUB.)	(LOCTITE 262)	(LOCTITE 242 OR 271)	(DRY OR LOC. 263)	(LUB.)	(LOCTITE 262)	(LOCTITE 242 OR 271)	(DRY OR LOC. 263)	(LUB.)	(LOCTITE 262)	(LOCTITE 242 OR 271)	
4	40	0.2845	0.0153	172	1	1	—	—	—	245	2	1	—	—	—	—
48	48	0.0168	0.0168	191	1	1	—	—	272	2	1	—	—	—	—	—
6	32	0.3505	0.0232	263	2	2	—	—	372	3	2	—	—	—	—	—
40	40	0.0258	0.0258	277	2	2	—	—	417	3	2	—	—	—	—	—
8	32	0.4166	0.0356	408	4	3	—	—	572	5	4	—	—	—	—	—
36	36	0.0445	0.0374	426	4	3	—	—	599	5	4	—	—	—	—	—
10	24	0.4826	0.0445	508	5	4	—	—	717	7	5	—	—	—	—	—
32	32	0.0508	0.0508	583	6	4	—	—	817	8	6	—	—	—	—	—
1/4	20	0.6350	0.0808	916	11	9	—	12	1297	16	12	—	18	1442	18	18
28	28	0.0925	0.0925	1052	14	10	—	16	1488	19	14	—	21	1651	19	19
5/16	18	0.7938	0.1331	1515	23	18	22	26	2141	34	25	30	41	2377	34	34
24	24	0.1473	0.1473	1678	26	19	23	29	2821	34	27	34	41	2631	37	37
3/8	16	0.9525	0.1969	2241	41	31	38	48	3175	61	48	54	68	3493	61	61
24	24	0.2230	0.2230	2540	48	34	43	54	3583	68	48	61	75	3983	68	68
7/16	14	1.1112	0.2700	3085	68	48	61	75	4332	95	75	85	109	4822	95	95
20	20	0.3015	0.3015	3425	75	68	68	81	4854	109	81	95	122	5384	102	102
1/2	13	1.2700	0.3604	4105	102	75	92	115	5783	149	109	130	163	6437	149	149
20	20	0.4061	0.4061	4854	122	88	108	136	6532	163	122	146	183	7253	156	156
9/16	12	1.4288	0.4623	5262	149	109	133	163	7539	204	149	188	224	8256	210	210
18	18	0.5156	0.5156	5874	163	122	148	183	8278	231	176	209	258	9208	224	224
5/8	11	1.5875	0.5740	6532	204	149	183	224	9231	298	231	244	326	10251	285	285
18	18	0.6502	0.6502	7394	231	176	207	258	10433	326	244	277	359	11612	298	298
3/4	10	1.9050	0.8484	9662	353	271	325	387	13653	515	380	408	570	15150	495	495
16	16	0.9474	0.9474	10796	407	298	363	448	15241	570	434	456	631	16919	542	542
7/8	9	2.2225	1.1735	13336	583	434	523	644	18870	814	624	658	895	20956	793	793
14	14	1.2929	1.2929	14697	637	475	576	705	20775	895	678	724	983	23088	861	861
1	8	2.5400	1.5392	17509	868	651	785	915	23360	1220	922	931	1342	27488	1173	1173
12	12	1.6840	1.6840	19142	949	719	858	997	27080	1356	1003	1079	1492	30074	1241	1241
1-1/8	7	2.8575	1.9380	19187	1085	814	968	1139	31162	1736	1302	1396	1898	34610	1681	1681
12	12	2.1742	2.1742	21546	1193	895	1087	1254	34927	1953	1464	1566	2136	38828	1871	1871
1-1/4	7	3.1750	2.4613	24404	1519	1139	1368	1593	38554	2468	1844	1970	2712	43954	2373	2373
12	12	2.7254	2.7254	27035	1681	1247	1516	1762	43818	2712	2034	2183	2983	48671	2549	2549
1-1/2	6	3.4925	2.9337	29076	1980	1492	1792	2068	47174	3227	2413	2586	3559	52391	3145	3145
12	12	3.3401	3.3401	33113	2278	1708	2042	2373	53570	3688	2766	2935	4068	59648	3308	3308
1-1/2	6	3.8100	3.5687	35381	2630	1980	2379	2746	57380	4284	3200	3430	4712	63731	4122	4122
12	12	4.0132	4.0132	39781	2983	2224	2676	3118	142200	4827	3607	3856	5322	71669	4433	4433

Note: These torque values do not apply to cadmium plated fasteners.



SAE GRADE 5



SAE GRADE 8

Figure 2-6. Torque Chart

SECTION 3. USER RESPONSIBILITIES AND MACHINE CONTROL

3.1 GENERAL

⚠ IMPORTANT

SINCE THE MANUFACTURER HAS NO DIRECT CONTROL OVER MACHINE APPLICATION AND OPERATION, CONFORMANCE WITH GOOD SAFETY PRACTICES IN THESE AREAS IS THE RESPONSIBILITY OF THE USER AND HIS/HER OPERATING PERSONNEL.

This section provides the necessary information needed to understand control functions. Included in this section are the operating characteristics and limitations, and functions and purposes of controls and indicators. It is important that the user and/or operator read and understand the proper procedures before operating the machine. These procedures will aid in obtaining optimum lift service and safe operation.

3.2 PERSONNEL TRAINING

The aerial platform is a personnel handling device; therefore it is essential that it be operated and maintained only by authorized and qualified personnel who have demonstrated that they understand the proper use and maintenance of the machine. It is important that all personnel who are assigned to and responsible for the operation and maintenance of the machine undergo a thorough training program and check out period in order to become familiar with the characteristics prior to operating the machine.

Persons under the influence of drugs or alcohol or who are subject to seizures, dizziness or loss of physical control must not be permitted to operate the machine.

Operator Training

Operator training must include instruction in the following areas:

1. Use and limitations of the platform controls, ground controls, emergency controls and safety systems.
2. Knowledge and understanding of this manual and of the control markings, instructions and warnings on the machine itself.

3. Knowledge and understanding of all safety work rules of the employer and of Federal, State and local statutes, including training in the recognition and avoidance of potential hazards in the work place; with particular attention to the work to be performed.
4. Proper use of all required personnel safety equipment, in particular the wearing of a safety harness or other approved fall protection devices with a lanyard attached to the platform at all times.
5. Sufficient knowledge of the mechanical operation of the machine to recognize a malfunction or potential malfunction.
6. The safest means to operate the machine where overhead obstructions, other moving equipment, and obstacles, depressions, holes, drop-offs, etc. on the supporting surface exist.
7. Means to avoid the hazards of unprotected electrical conductors.
8. Any other requirements of a specific job or machine application.

Training Supervision

Training must be done under the supervision of a qualified person in an open area free of obstructions until the trainee has developed the ability to safely control a machine in congested work locations.

Operator Responsibility

The operator must be instructed that he/she has the responsibility and authority to shut down the machine in case of a malfunction or other unsafe condition of either the machine or the job site and to request further information from his/her supervisor or an authorized JLG Distributor before proceeding.

NOTE: *Manufacturer or distributor will provide qualified persons for training assistance with first unit(s) delivered and thereafter as requested by the user or his/her personnel.*

3.3 OPERATING CHARACTERISTICS AND LIMITATIONS

General

A thorough knowledge of the operating characteristics and limitations of the machine is always the first requirement for any user, regardless of the user's experience with similar types of equipment.

Placards

Important points to remember during operation are provided at the control stations by DANGER, WARNING, CAUTION, IMPORTANT and INSTRUCTION placards. This information is placed at various locations for the express purpose of alerting personnel of potential hazards constituted by the operating characteristics and load limitations of the machine. See FOREWORD for definitions of the above placards.

Capacities

Raising boom above horizontal and/or extension of boom beyond retracted position with or without any load in platform, is based on the following criteria:

1. Machine is positioned on a smooth, firm and level surface.
2. Load is within manufacturer's rated design capacity.
3. All machine systems are functioning properly.
4. Proper tire pressure exists in the tires.
5. Machine is as originally equipped from JLG.

Stability

This machine as originally manufactured by JLG Industries Inc., when operated within its rated capacity on a smooth, firm and level supporting surface, and in accordance with the instructions provided on the machine and this manual, provides a stable machine for all platform positions.

Machine stability is based on two positions which are called FORWARD STABILITY and BACKWARD STABILITY. The machine's position of least forward stability is shown in Figure 3-1., and its position of least backward stability is shown in Figure 3-2.

WARNING

TO AVOID FORWARD OR BACKWARD UPSET, DO NOT OVERLOAD MACHINE OR OPERATE ON AN OUT-OF-LEVEL SURFACE.

Boom Synchronizing Procedure

If the lower boom does not fully lower, use the following procedure.

1. Remove all personnel from the platform.
2. Pull out the red EMS (emergency stop) knob located on the ground control station.
3. Turn the platform/ground select switch to the ground control position.
4. If applicable, start the engine.
5. Pull and hold out the red re-level knob on the synchronizing valve located beside the main control valve.
6. From the ground controls, activate the lift control switch, and raise the lower boom approximately 2 m (6 feet).
7. After raising the lower boom, release the red knob.
8. Activate the lift control switch and fully lower the boom and continue to hold down the switch for an additional 5 seconds.
9. Repeat steps 5 thru 8 if necessary.

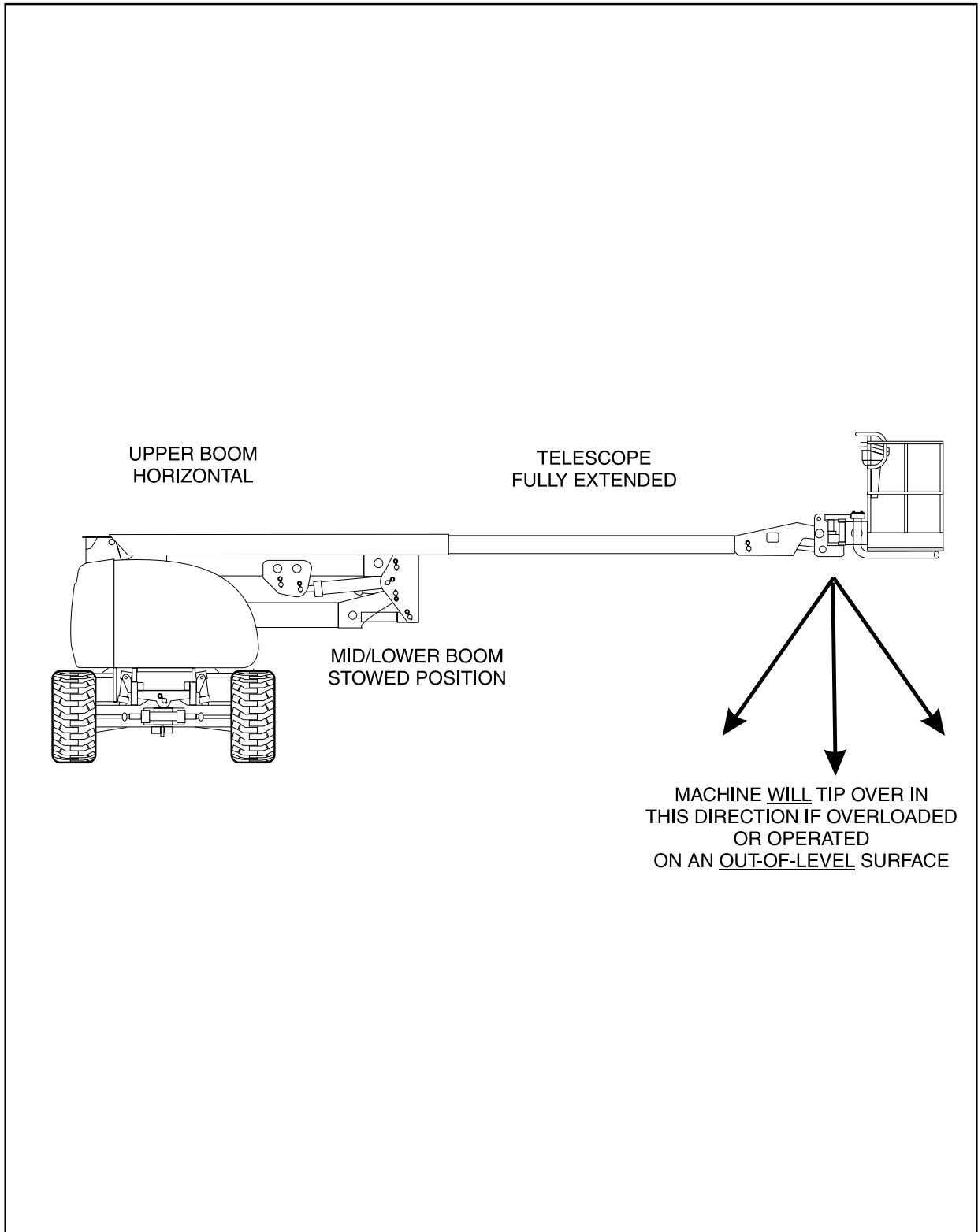

Figure 3-1. Position of Least Forward Stability

SECTION 3 - USER RESPONSIBILITIES AND MACHINE CONTROL

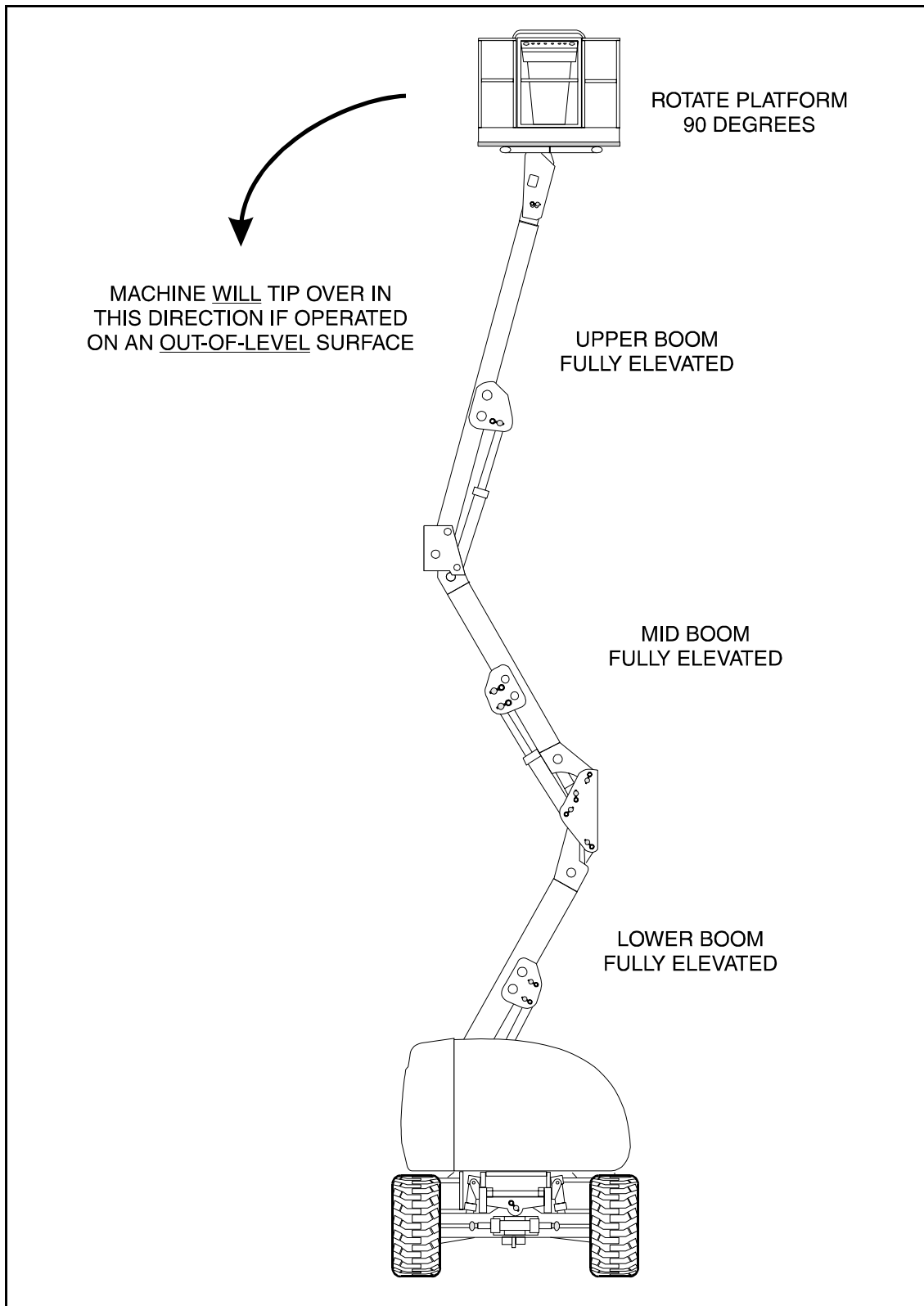

Figure 3-2. Position of Least Backward Stability

3.4 CONTROLS AND INDICATORS

NOTE: This machines is equipped with control panels that use symbols to indicate control functions. Refer to Figure 3-7. and Figure 3-8. for the symbols on the decal located on the control box guard in front of the control box or by the ground controls for these control panel symbols and the corresponding functions.

Ground Controls

PERFORM PRE-OPERATIONAL CHECKS AND INSPECTIONS FROM THE GROUND CONTROL STATION. WHEN PERSONNEL ARE IN THE PLATFORM, OPERATION OF THE BOOM WILL ONLY BE PERFORMED WITH THE PERMISSION OF THE PLATFORM OCCUPANT(S).

NOTE: When Power/Emergency Stop switch is in the on position and engine is not running, an alarm will sound, indicating Ignition is on.

⚠ CAUTION

WHEN THE MACHINE IS SHUT DOWN THE MASTER/EMERGENCY STOP SWITCH MUST BE POSITIONED TO THE OFF POSITION TO PREVENT DRAINING THE BATTERY.

1. Power/Emergency Stop Switch.

Pull out on-off Power/Emergency Stop Switch to turn on engine ignition and power to the electrical system. Push in to shut off engine and remove power from the controls. The Ground Control Emergency Stop Switch must be pulled out to operate the machine from either Ground Control or Platform Control. This allows the machine to be shut down in emergency situations by those untrained in the operation of the lift but who recognize the Emergency Stop Switch. The keyed Master Switch can also be used for the same purpose.

2. Engine Start/ Auxiliary Power Switch.

A toggle-type Engine Start/Auxiliary Power control switch, on the ground control panel, energizes the engine starter or the electrically operated auxiliary hydraulic pump, when actuated. To start the engine, the switch must be held up until the engine starts. To use auxiliary power, the switch must be held down for duration of auxiliary pump use.

NOTE: Auxiliary power only works if there is no oil pressure, and is disabled if engine is running.

- a. The auxiliary pump functions to provide sufficient oil flow to operate the basic machine functions should the main pump or engine fail. The

auxiliary pump enables the tower boom lift and telescope and swing to be operated.

- b. It should be noted that the functions will operate at a slower than normal rate because of the lower flow of hydraulic fluid delivered.

NOTE: When operating on auxiliary power, do not operate more than one function at a time. (Simultaneous operation can overload the 12-volt auxiliary pump motor.)

- c. Position PLATFORM/GROUND switch to GROUND.
- d. Position POWER/EMERGENCY STOP switch to ON.
- e. Operate appropriate control switch or lever for desired function and hold.
- f. Position ENGINE START/AUXILIARY POWER switch to DOWN and hold.
- g. Release AUXILIARY POWER switch, followed by the selected control switch or lever.
- h. Position the POWER/EMERGENCY STOP SWITCH to off.

3. Control Station Selector.

A three position, center off, key activated PLATFORM/GROUND SELECT switch supplies power to the platform control console when positioned to PLATFORM. With the switch in GROUND position, power is shut off to the platform control console, and only the controls on the ground control panel are operable.

NOTE: With the Platform/Ground Select Switch in the center position, power is shut off to controls at both operating stations. Remove the key to prevent the controls from being actuated.

NOTE: Engine Start/Auxiliary Power, Main Lift, Swing, Platform Level, Main Telescope, Tower Lift and Platform Rotator control switches are spring-loaded and will automatically return to neutral (off) when released.

⚠ CAUTION

WHEN OPERATING THE BOOM ENSURE THERE ARE NO PERSONNEL AROUND OR UNDER PLATFORM.

⚠ CAUTION

TO AVOID SERIOUS INJURY, DO NOT OPERATE MACHINE IF ANY CONTROL LEVERS OR TOGGLE SWITCHES CONTROLLING PLATFORM MOVEMENT DO NOT RETURN TO THE OFF POSITION WHEN RELEASED.

SECTION 3 - USER RESPONSIBILITIES AND MACHINE CONTROL

4. Tower Lift.

The Tower Lift control switch provides raising and lowering of the lower and mid booms when positioned up or down.

5. Main Lift Control.

The Main Lift control switch provides raising and lowering of the main boom when positioned up or down.

6. Main Telescope Control.

The Main Telescope control switch provides extension and retraction of the main boom, when positioned to in or out.

7. Swing Control.

The Swing control switch provides 360 degrees non-continuous turntable rotation when positioned to the right or left.

8. Hourmeter.

An hourmeter, installed in the bottom left of the Ground Control box, registers the amount of time the machine has been in use, with engine running. By connecting into the oil pressure circuit of the engine, only engine run hours are recorded. The hourmeter registers up to 9,999.9 hours and cannot be reset.

9. Platform Rotate.

A three position Rotate control switch permits rotation of the platform when positioned to the left or right.

10. Platform Leveling Override.

A three position Platform Leveling Override control switch allows the operator to compensate for any difference in the automatic self leveling system by positioning the control switch up or down.

11. Articulating Jib Boom. (If Equipped)

The Articulating Jib Boom control switch provides raising and lowering of the jib when positioned up or down.

12. Battery Charging Indicator.

When illuminated indicates a problem in the battery or charging circuit, and service is required.

13. Engine Air Filter Indicator.

When illuminated indicates that the air filter is too restrictive and needs to be replaced.

14. Engine Oil Pressure Indicator.

When illuminated indicates that engine oil pressure is below normal and service is required.

15. Engine Coolant Temperature (Ford and Isuzu) Indicator.

When illuminated indicates that engine coolant temperature is abnormally high and service is required.

16. Engine Oil Temperature Indicator (Deutz).

When illuminated indicates that the temperature of the engine oil, which also serves as engine coolant, is abnormally high and service is required.

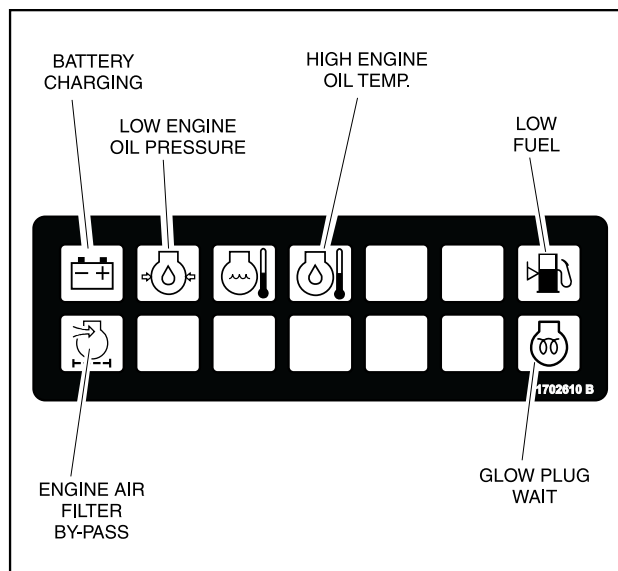

Figure 3-3. Ground Control Indicator Panel

SECTION 3 - USER RESPONSIBILITIES AND MACHINE CONTROL

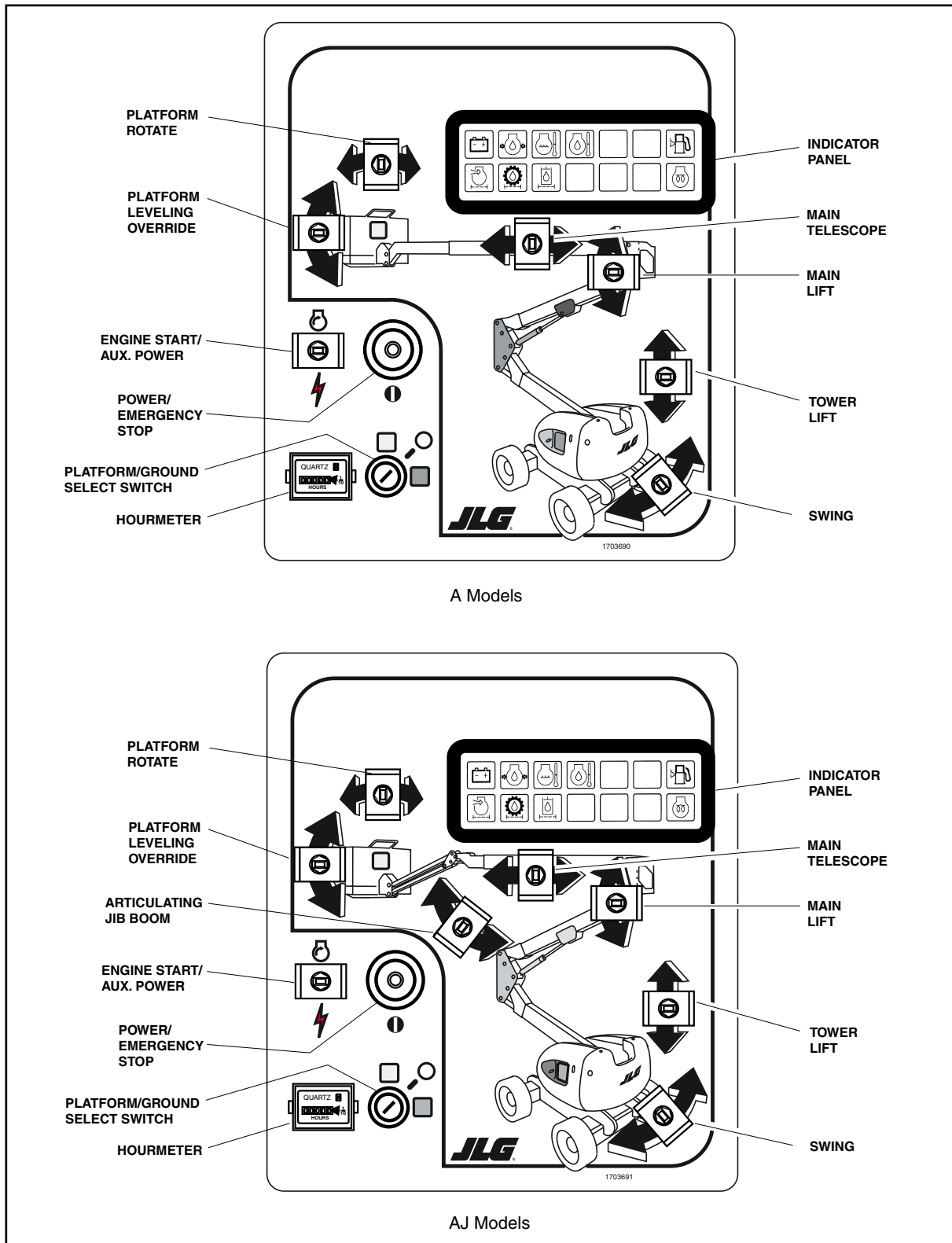

Figure 3-4. Ground Control Station

SECTION 3 - USER RESPONSIBILITIES AND MACHINE CONTROL

17. Low Fuel Level Indicator.

When illuminated indicates that the fuel level is 1/8 full or less. When the light first turns on, there are approximately four usable gallons of fuel remaining.

18. Glow Plug Wait Indicator.

When illuminated, indicates the glow plugs are on. The glow plugs are automatically turned on with the ignition circuit and remain on for approximately seven seconds. Start the engine only after the light goes out.

Platform Station

NOTE: For engine starting, the footswitch must be in the released (up) position. Footswitch must be actuated in order for the platform controls to function.

NOTE: These machines have a 7 second delay timer. If function has not been activated within 7 seconds after depressing the footswitch, recycle footswitch.

1. Footswitch.

This feature makes it necessary to depress the footswitch to allow operation of the platform controls.

⚠ WARNING

TO AVOID SERIOUS INJURY, DO NOT REMOVE, MODIFY OR DISABLE THE FOOTSWITCH BY BLOCKING OR ANY OTHER MEANS.

⚠ IMPORTANT

FOOTSWITCH MUST BE ADJUSTED SO THAT FUNCTIONS WILL OPERATE WHEN PEDAL IS APPROXIMATELY AT ITS CENTER OF TRAVEL. IF SWITCH OPERATES WITHIN LAST 6.5 MM OF TRAVEL, TOP OR BOTTOM, IT SHOULD BE ADJUSTED.

2. Power/Emergency Stop.

An on-off Power/Emergency Stop switch and a separate Engine Start/Auxiliary Power toggle switch on the platform console supply electrical power to the starter solenoid, when the ignition switch is placed in the ON position and the ENGINE START switch is push forward.

3. Enable Indicator. (Green)

This green illuminator indicates that the footswitch is depressed and the platform controls are ready for use. To enable the controls, depress the footswitch and select any function within seven seconds. The controls will then remain active as long as there is not a delay of seven seconds between stopping one function and starting the next one. If the seven sec-

ond interval is exceeded, the enable light will go out and the controls will not operate. To enable the controls again, remove your foot from the footswitch and depress the footswitch.

4. Travel Warning Horn.

A push-type horn switch supplies electrical power to an audible warning device when pressed.

5. Tilt Alarm Warning Light. (Orange)

This orange illuminator indicates that the chassis is on a slope (over 3 degrees). If illuminated when boom is raised or extended, retract and lower to below horizontal then reposition machine so that it is level before extending boom or raising boom above horizontal. If the boom is above horizontal and the machine is on a 3 degree slope, an alarm will sound and Creep is automatically activated.

⚠ WARNING

IF ILLUMINATED WHEN BOOM IS RAISED OR EXTENDED, RETRACT AND LOWER TO BELOW HORIZONTAL THEN REPOSITION MACHINE SO THAT IT IS LEVEL BEFORE EXTENDING BOOM OR RAISING BOOM ABOVE HORIZONTAL.

6. Tower or Lower Boom Lift.

The three position center-off toggle switch provides for raising and lowering of the lower and mid booms when positioned up or down.

NOTE: Main Lift, Swing, and Drive control levers are spring-loaded and will automatically return to neutral (off) position when released.

⚠ WARNING

TO AVOID SERIOUS INJURY, DO NOT OPERATE MACHINE IF ANY CONTROL LEVERS OR TOGGLE SWITCHES CONTROLLING PLATFORM MOVEMENT DO NOT RETURN TO THE OFF OR NEUTRAL POSITION WHEN RELEASED.

7. Main Lift/Swing Controller.

The dual axis joystick is provided for main lift and swing. Push forward to lift up, pull backward to lift down. Move right to swing right, move left to swing left. Moving the joystick activates switches to provide the functions selected. Proportional control of these functions can be attained by using the Function Speed knob.

NOTE: Main lift and swing functions may be selected in combination. The handle features a round gate so that maximum speed is reduced when multiple functions are selected.

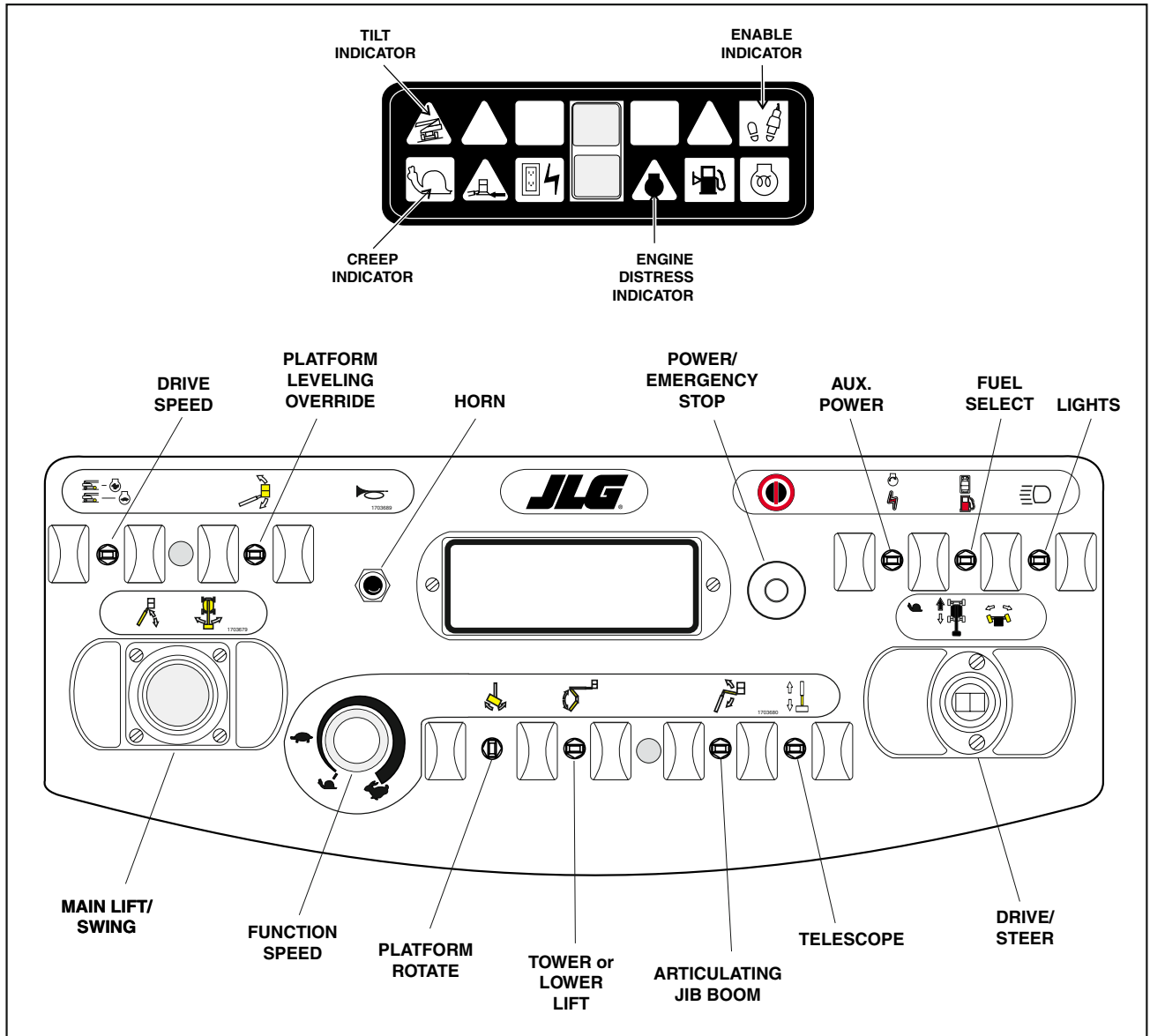

Figure 3-5. Platform Station

8. Main Telescope Control.

The Main Telescope control switch allows extension and retraction of the main boom when positioned to in or out.

9. Drive/Steer.

Proportional single axis joystick is provided to control drive. Push forward to drive forward, pull back to drive in reverse. Steering is accomplished via a thumb-activated rocker switch on the end of the

handle. Push on the left side of the switch to steer left, on right side to steer right.

NOTE: Both drive and steer functions work in the opposite direction when the boom is positioned over front of the chassis.

NOTE: When boom is positioned above horizontal and any of the following switches, Drive Speed/Torque Select or Function Speed, are positioned to High, high function speeds are automatically cut out and the machine continues to operate at a lower speed.

SECTION 3 - USER RESPONSIBILITIES AND MACHINE CONTROL

CAUTION

DO NOT OPERATE MACHINE IF DRIVE SPEED/TORQUE SELECT OR FUNCTION SPEED SWITCHES OPERATE WHEN BOOM IS ABOVE HORIZONTAL.

10. Function Speed.

The knob provides variable speed control of all boom functions grouped to the right of the knob. For smoothest operation of these functions, use two hands: rotate the knob counterclockwise to the slowest position, select the function switch, and while holding the switch on, rotate the knob to the desired speed. To achieve a smooth stop, rotate the knob ccw to a slow speed prior to letting go of the function switch.

Rotating the knob fully counterclockwise until a click is heard puts all controls, including drive, main lift, and swing into creep speed. This slow speed is used for fine positioning of the platform when close to obstacles. A snail symbol is used to indicate "creep" speed and is shown at the Function Speed knob as well as near the proportional controllers to act as a reminder.

11. Drive Speed Switch (4WD Equipped Machines).

On machines equipped with 4WD, the drive speed switch also selects 2WD or 4WD modes. The forward position produces maximum speed by operating in 2WD at high engine rpm. The center position selects 4WD at mid engine rpm. The backward position selects 4WD at high engine rpm.

12. Drive Speed Switch (2WD Equipped Machines).

The forward position produces maximum speed by operating at high engine rpm. The backward position selects mid engine rpm.

13. Creep Speed Indicator.

Illuminated (Green) when the Function Speed Control is turned to the creep position, the indicator acts as a reminder that all functions are set to the slowest speed.

14. Platform Rotate.

The Platform Rotate control switch allows the operator to rotate the basket to the left or right when positioned to the desired direction.

15. Platform Leveling Override.

The Platform Level control switch allows the operator to adjust the level of the platform by positioning the switch to UP or DOWN.

16. Articulating Jib Boom. (If Equipped)

Push level, toggle switch forward to lift up, pull back to lift down.

17. Fuel Select (Dual Fuel Engine Only). (If Equipped)

Gasoline or liquid propane fuel may be selected by moving the switch to the appropriate position. It is unnecessary to purge the fuel system before switching fuels, so there is no waiting period when switching fuels while the engine is running.

18. Lights. (If Equipped)

This switch operates control console panel lights and head lights if the machine is so equipped. The ignition switch does not have to be on to operate the lights, so care must be taken to avoid draining the battery if left unattended. The master switch and / or the ignition switch at the ground control will turn off power to all lights.

19. Engine Distress Indicator Light (Yellow).

The light turns on and an alarm sounds when machine's power system requires immediate service. Any of the following conditions will turn on light and alarm: low engine oil pressure, high engine coolant temperature, clogged engine air filter, low alternator output, clogged hydraulic oil return filter, or clogged charge pump filter.

20. Soft Touch Indicator. (If Equipped)

When illuminated (Yellow) the Soft Touch bumper is against an object. All controls are cut out until the override button is pushed, at which time controls are active in the Creep mode.

21. AC Generator. (Green)

When illuminated (Green), the light indicates the generator is in operation.

22. Low Fuel Indicator. (Yellow)

When illuminated (Yellow), the fuel tank is 1/8 full or less. When the light first turns on, there are approximately four usable gallons of fuel remaining.

23. Auxiliary Power.

A toggle-type Auxiliary Power control switch energizes the electrically operated hydraulic pump, when actuated. (Switch must be held ON for duration of auxiliary pump use.)

The auxiliary pump functions to provide sufficient oil flow to operate the basic machine functions should the main pump or engine fail. The auxiliary pump will operate tower boom lift, tower telescope, main boom lift, main telescope and swing.

It should be noted that the functions will operate at a slower than normal rate because of the lower gpm delivered.

⚠ IMPORTANT

WHEN OPERATING ON AUXILIARY POWER, DO NOT OPERATE MORE THAN ONE FUNCTION AT THE SAME TIME. SIMULTANEOUS OPERATION CAN OVERLOAD THE AUXILIARY PUMP MOTOR.

NOTE: *The main function of auxiliary power is to lower the platform in the event of primary power failure. Determine the reason for primary power failure and have the problem corrected by a certified JLG service technician. Operate as follows:*

- a. Position Platform/Ground switch to Platform.
- b. Position Power/Emergency Stop switch to the on position.
- c. Depress and hold footswitch.
- d. Operate appropriate control switch or lever for desired function and hold.
- e. Position Auxiliary Power switch to the on position and hold.
- f. Release Auxiliary Power switch, selected control switch or lever, and footswitch.
- g. Position Power/Emergency Stop switch to the off position.

3.5 PLACARDS AND DECALS

Read and understand all placards and decals. Do not operate any machine on which DANGER, WARNING, CAUTION OR INSTRUCTION PLACARDS OR DECALS ARE MISSING OR ILLEGIBLE. Replace placards and decals if damaged, missing or illegible.

Decals are made of Lexan Pressure Sensitive Adhesive with a protective film on the front. Remove the damaged decal and thoroughly clean surface before installing a new decal. Simply peel off the back, and press new decal onto surface.

NOTE: *Placards and Decals can be ordered by using part numbers located by each placard or decal. (See Figure 3-7. Danger and Warning Decal Location.)*

SECTION 3 - USER RESPONSIBILITIES AND MACHINE CONTROL

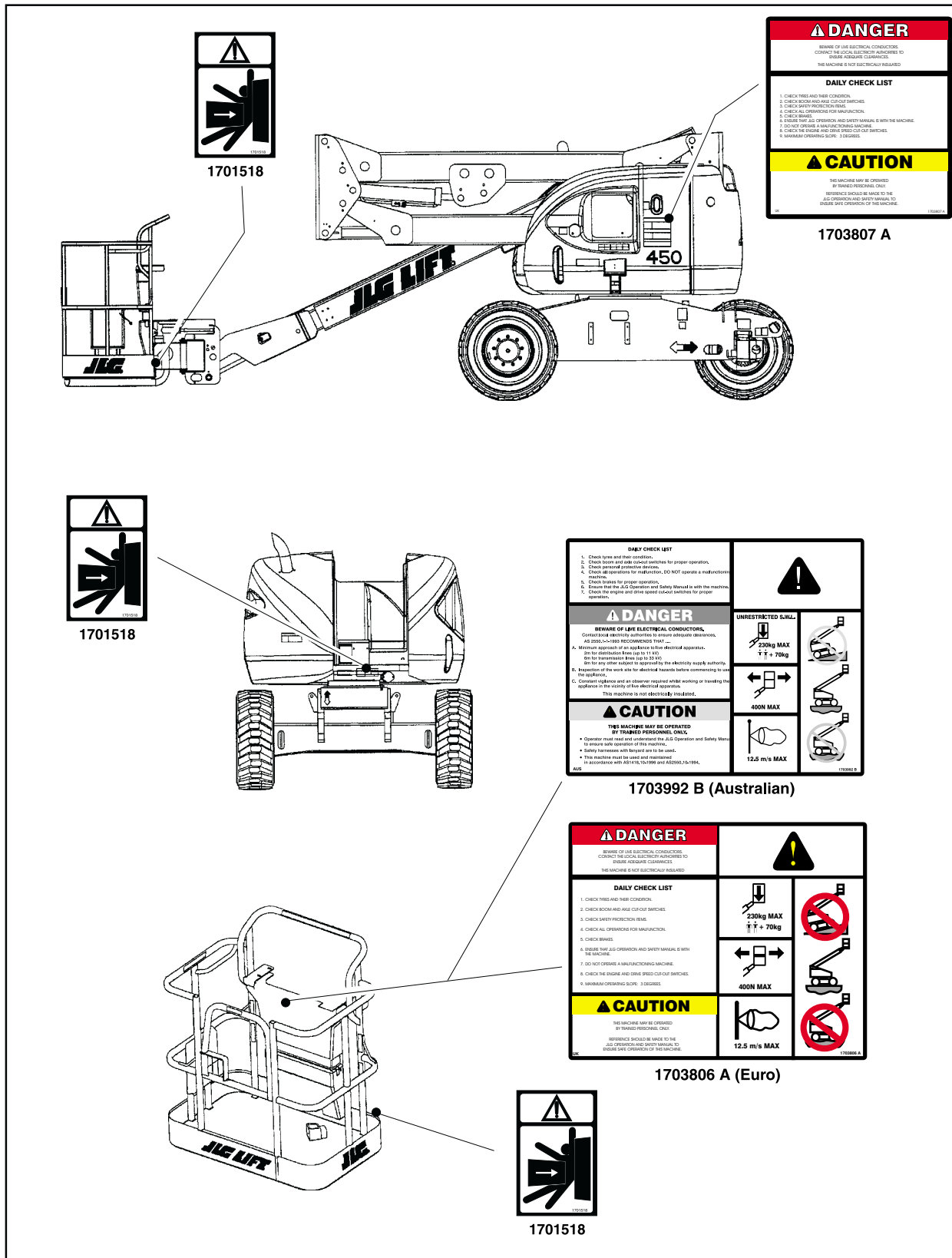





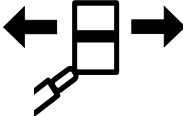

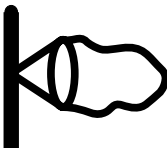



Figure 3-6. Danger and Warning Decal Location













1701518

 DANGER		
<p>BEWARE OF LIVE ELECTRICAL CONDUCTORS. CONTACT THE LOCAL ELECTRICITY AUTHORITIES TO ENSURE ADEQUATE CLEARANCES.</p> <p>THIS MACHINE IS NOT ELECTRICALLY INSULATED</p>		
DAILY CHECK LIST	 230kg MAX  + 70kg	
<ol style="list-style-type: none"> 1. CHECK TYRES AND THEIR CONDITION. 2. CHECK BOOM AND AXLE CUT-OUT SWITCHES. 3. CHECK SAFETY PROTECTION ITEMS. 4. CHECK ALL OPERATIONS FOR MALFUNCTION. 5. CHECK BRAKES. 6. ENSURE THAT JLG OPERATION AND SAFETY MANUAL IS WITH THE MACHINE. 7. DO NOT OPERATE A MALFUNCTIONING MACHINE. 8. CHECK THE ENGINE AND DRIVE SPEED CUT-OUT SWITCHES. 9. MAXIMUM OPERATING SLOPE: 3 DEGREES. 	 400N MAX	
 CAUTION	 12.5 m/s MAX	
<p>THIS MACHINE MAY BE OPERATED BY TRAINED PERSONNEL ONLY.</p> <p>REFERENCE SHOULD BE MADE TO THE JLG OPERATION AND SAFETY MANUAL TO ENSURE SAFE OPERATION OF THIS MACHINE.</p>	<p>1703806 A</p>	

1703806 A

 DANGER
<p>BEWARE OF LIVE ELECTRICAL CONDUCTORS. CONTACT THE LOCAL ELECTRICITY AUTHORITIES TO ENSURE ADEQUATE CLEARANCES.</p> <p>THIS MACHINE IS NOT ELECTRICALLY INSULATED</p>
<p>DAILY CHECK LIST</p> <ol style="list-style-type: none"> 1. CHECK TYRES AND THEIR CONDITION. 2. CHECK BOOM AND AXLE CUT-OUT SWITCHES. 3. CHECK SAFETY PROTECTION ITEMS. 4. CHECK ALL OPERATIONS FOR MALFUNCTION. 5. CHECK BRAKES. 6. ENSURE THAT JLG OPERATION AND SAFETY MANUAL IS WITH THE MACHINE. 7. DO NOT OPERATE A MALFUNCTIONING MACHINE. 8. CHECK THE ENGINE AND DRIVE SPEED CUT-OUT SWITCHES. 9. MAXIMUM OPERATING SLOPE: 3 DEGREES.
 CAUTION
<p>THIS MACHINE MAY BE OPERATED BY TRAINED PERSONNEL ONLY.</p> <p>REFERENCE SHOULD BE MADE TO THE JLG OPERATION AND SAFETY MANUAL TO ENSURE SAFE OPERATION OF THIS MACHINE.</p>
UK 1703807 A

1703807 A

<p style="text-align: center;">DAILY CHECK LIST</p> <ol style="list-style-type: none"> 1. Check tyres and their condition. 2. Check boom and axle cut-out switches for proper operation. 3. Check personal protective devices. 4. Check all operations for malfunction. DO NOT operate a malfunctioning machine. 5. Check brakes for proper operation. 6. Ensure that the JLG Operation and Safety Manual is with the machine. 7. Check the engine and drive speed cut-out switches for proper operation. 	
 DANGER	<p style="text-align: center;">UNRESTRICTED S.W.L.</p> <div style="display: flex; justify-content: space-around;"> <div style="text-align: center;">  230kg MAX  + 70kg </div> <div style="text-align: center;">  400N MAX </div> <div style="text-align: center;">  12.5 m/s MAX </div> </div>
<p style="text-align: center;">BEWARE OF LIVE ELECTRICAL CONDUCTORS. Contact local electricity authorities to ensure adequate clearances. AS 2550.1-1-1993 RECOMMENDS THAT</p> <p>A. Minimum approach of an appliance to live electrical apparatus. 2m for distribution lines (up to 11 kV) 6m for transmission lines (up to 33 kV) 8m for any other subject to approval by the electricity supply authority.</p> <p>B. Inspection of the work site for electrical hazards before commencing to use the appliance.</p> <p>C. Constant vigilance and an observer required whilst working or traveling the appliance in the vicinity of live electrical apparatus.</p> <p style="text-align: center;">This machine is not electrically insulated.</p>	<div style="display: flex; flex-direction: column; align-items: center;">    </div>
 CAUTION	<p style="text-align: center;">THIS MACHINE MAY BE OPERATED BY TRAINED PERSONNEL ONLY.</p> <ul style="list-style-type: none"> • Operator must read and understand the JLG Operation and Safety Manual to ensure safe operation of this machine. • Safety harnesses with lanyard are to be used. • This machine must be used and maintained in accordance with AS1418.10-1996 and AS2550.10-1994.
AUS 1703992 B	

1703992 B

SECTION 3 - USER RESPONSIBILITIES AND MACHINE CONTROL







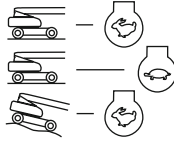
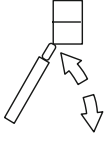
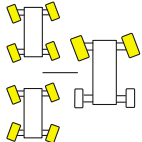
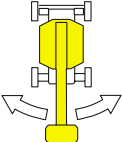
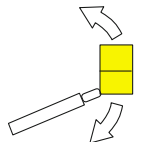
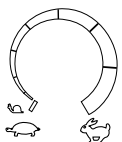
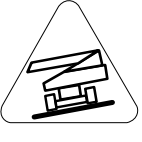
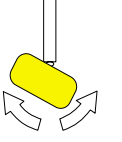

FUNCTION	SYMBOL	FUNCTION	SYMBOL
DRIVE SELECT		MAIN LIFT	
STEER SELECT		SWING	
PLATFORM LEVEL		FUNCTION SPEED CONTROL	
CHASSIS OUT OF LEVEL		PLATFORM ROTATE	
CREEP		TOWER LIFT	
PLATFORM CAPACITY INDICATOR		TOWER TELESCOPE	
ENGINE DISTRESS		ARTICULATING FLY BOOM	
LOW FUEL LEVEL		MAIN TELESCOPE	
AC GENERATOR ON		FUEL SELECT	

Figure 3-7. Control Panel Symbols - Sheet 1 of 2

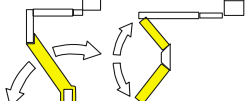
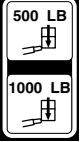
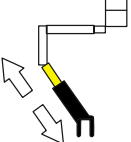
SECTION 3 - USER RESPONSIBILITIES AND MACHINE CONTROL

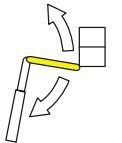

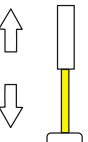



FUNCTION	SYMBOL	FUNCTION	SYMBOL
GLOW PLUG INDICATOR		SOFT TOUCH OVERRIDE	
ENABLE INDICATOR		SOFT TOUCH INDICATOR	
POWER EMERGENCY STOP		DRIVE	
START AUXILIARY POWER		STEER	

Figure 3-8. Control Panel Symbols - Sheet 2 of 2

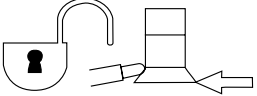
SECTION 4. MACHINE OPERATION

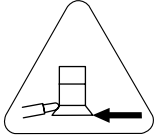
4.1 DESCRIPTION

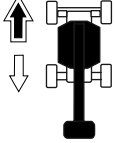
This machine is a self-propelled aerial work platform on the end of an elevating, telescoping and rotating boom. The JLG Lift is intended purpose is to position personnel with their tools and supplies at positions above ground level. The machine can be used to reach work areas located above and over machinery or equipment.

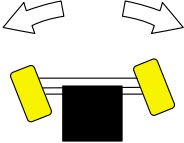
The JLG Lift has a primary operator Control Station in the platform. From this Control Station, the operator can drive and steer the machine in both forward and reverse directions. The operator can raise, lower, extend or retract the boom; swing the boom to the left or right; and when equipped with a platform rotator, can rotate the platform around the boom end. Standard boom swing is 357° non-continuous left and right of the stowed position. The machine has a Ground Control Station which will override the Platform Control Station. Ground Controls operate Tower Lift, Main Boom Lift, Main Boom Telescope and Swing and are to be used only in an emergency to lower the platform to the ground should the operator in the platform be unable to do so.

Instruction and hazard warnings are posted adjacent to both operator control stations and at other places on the machine. It is extremely important that operators know what instructions and warnings are placed on the machine, and review these periodically so that they are fresh in their minds.

The JLG Lift is designed to provide efficient and safe operation when maintained and operated in accordance with warnings on the machine, in the Operators and Safety Manual, and all jobsite and government rules and regulations. As with any type of machinery, the operator is very important to efficient and safe operation. It is absolutely necessary that the JLG Lift be regularly maintained in accordance with this manual and the machine Service and Maintenance manual, and that any evidence of lack of maintenance, malfunction, excessive wear, damage or modification to the machine be reported immediately to the machine owner or the jobsite supervisor or safety manager and that the machine be taken out of service until all discrepancies are corrected.

The JLG Lift is not intended to be used to lift material other than supplies which personnel in the platform require to do their job. Supplies or tools which extend outside the

platform are prohibited. It must not be used as a forklift, crane, support for overhead structure, or to push or pull another object.

The machine is equipped with an auxiliary battery operated power unit which will provide hydraulic power in the event of a primary engine power loss. Auxiliary power can be controlled from either the Platform Control Station or the Ground Control Station. Follow the instructions placed at the control stations.

The JLG Lift is hydraulically powered using hydraulic motors and cylinders for various machine motions. The hydraulic components are controlled by electrically activated hydraulic valves using switches and control levers. The speeds of functions controlled by control levers are variable from zero to maximum speed depending upon the position of the control lever. Functions controlled by toggle switches are either on or off and higher or lower speed is possible when the Function Speed control switch is used in conjunction with the function toggle switch. A foot operated switch in the platform must be depressed before any controls will function and provides a means of emergency stop when the operator's foot is removed from the footswitch.

The JLG Lift is a two wheel drive (four wheel drive available) machine with drive power being supplied by a hydraulic motor for each drive wheel. Each drive wheel is supplied with a hydraulically released, spring-applied brake (4WD machines only have brakes on the rear). These brakes are automatically applied any time the Drive Control lever is returned to the neutral position.

The unrestricted capacity of the JLG Lift is 230 kg. (500 lbs.) This means that with a platform load of 230 kg. (500 lbs.) or less, the platform may be positioned anywhere the boom will reach.

4.2 GENERAL

This section provides the necessary information needed to operate the machine. Included in this section are the procedures for starting, stopping, traveling, steering, parking, platform loading and transporting. It is important that the user read and understand the proper procedures before operating the machine.

4.3 ENGINE OPERATION

NOTE: Initial starting should always be performed from the Ground Control station.

Starting Procedure

1. Check engine oil. If necessary, add oil in accordance with the Engine Manufacturer's manual.
2. Check fuel level. Add fuel if necessary.
3. Check that air cleaner components are in place and securely fastened.

⚠ CAUTION

IF ENGINE FAILS TO START PROMPTLY, DO NOT CRANK FOR AN EXTENDED PERIOD. SHOULD ENGINE FAIL TO START ONCE AGAIN, ALLOW STARTER TO "COOL OFF" FOR 2-3 MINUTES. IF ENGINE FAILS AFTER SEVERAL ATTEMPTS, REFER TO ENGINE MAINTENANCE MANUAL.

NOTE: Machines with diesel engines. After turning on ignition, operator must wait until glow plug indicator light goes out before cranking engine.

4. Turn key of SELECT switch to GROUND. Position POWER/EMERGENCY STOP switch to ON, then push the ENGINE START switch to the upward position until engine starts.

⚠ CAUTION

ALLOW ENGINE TO WARM-UP FOR A FEW MINUTES AT LOW SPEED BEFORE APPLYING ANY LOAD.

5. After engine has had sufficient time to warm up, shut engine off.
6. Turn key of SELECT switch to PLATFORM.
7. From Platform position POWER/EMERGENCY STOP switch to ON, then push the ENGINE START switch to the forward position until engine starts.

NOTE: Footswitch must be in released (up) position before starter will operate. If starter operates with footswitch in the depressed position, DO NOT OPERATE MACHINE.

Shutdown Procedure

⚠ CAUTION

IF AN ENGINE MALFUNCTION NECESSITATES UNSCHEDULED SHUTDOWN, DETERMINE AND CORRECT CAUSE BEFORE RESUMING ANY OPERATION.

1. Remove all load and allow engine to operate at low speed setting for 3-5 minutes; this allows for further reduction of internal engine temperature.
2. Position POWER/EMERGENCY STOP switch to OFF.
3. Turn key of MASTER switch to OFF position.

NOTE: Refer to Engine Manufacturer's manual for detailed information.

4.4 TRAVELING (DRIVING)

⚠ WARNING

DO NOT DRIVE WITH BOOM EXTENDED OR ABOVE HORIZONTAL EXCEPT ON A SMOOTH, FIRM AND LEVEL SURFACE.

TO AVOID LOSS OF TRAVEL CONTROL OR UPSET ON GRADES AND SIDESLOPES, DO NOT DRIVE MACHINE ON GRADES OR SIDESLOPES EXCEEDING THOSE SPECIFIED ON MACHINE INFORMATION PLACARD ON THE LEFT SIDE OF THE FRAME.

TRAVEL GRADES WITH DRIVE SPEED/TORQUE SELECT SWITCH IN THE FORWARD POSITION. USE EXTREME CAUTION WHEN DRIVING IN REVERSE AND AT ALL TIMES WHEN DRIVING WITH PLATFORM ELEVATED AND ESPECIALLY WHEN DRIVING WITH ANY PART OF MACHINE WITHIN 2 M OF AN OBSTRUCTION. DO NOT USE DRIVE TO MANEUVER PLATFORM CLOSE TO AN OBSTRUCTION...USE ONE OF THE BOOM FUNCTIONS.

⚠ CAUTION

BEFORE DRIVING, MAKE SURE BOOM IS POSITIONED OVER REAR AXLE. IF BOOM IS OVER FRONT AXLE (STEER WHEELS), STEER AND DRIVE CONTROLS WILL MOVE IN OPPOSITE DIRECTIONS TO MACHINE CONTROLS.

Traveling Forward or Reverse

1. With engine running, depress footswitch and position DRIVE control to FORWARD and hold for the duration of forward travel desired.

NOTE: When DRIVE or STEER functions are being operated there is an interlock which prevents operation of boom functions.

2. Depress footswitch and position DRIVE control to REVERSE and hold for duration of reverse travel desired.
3. Depress footswitch and position STEER control to RIGHT for traveling right and LEFT for traveling left.

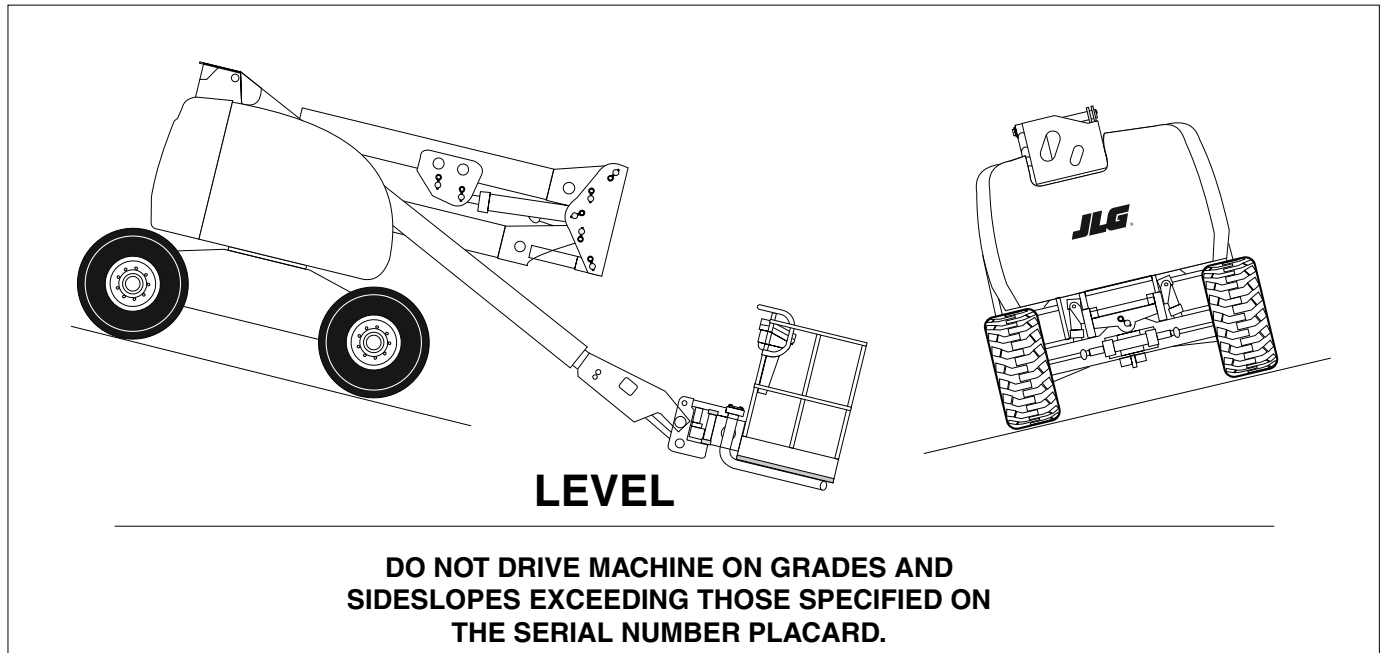

Figure 4-1. Grade and Sideslope

4. To obtain maximum travel speed, position the DRIVE controller to FAST and activate the following switches:

Position DRIVE SPEED/TORQUE SELECT switch to FAST. (Forward Position)

5. Prior to stopping the machine, position switches as follows:

Position DRIVE SPEED/TORQUE SELECT switch to LOW. (Backward Position)

6. For traveling up grades, position switches as follows:

Position DRIVE SPEED/TORQUE SELECT switch to HIGH.

NOTE: For smoother operation when driving with fully extended boom, place DRIVE control to SLOW before stopping.

4.5 STEERING

Depress footswitch to steer machine, push on the left side of the switch to steer left, on the right side to steer right.

CAUTION

BEFORE OPERATING MACHINE, MAKE SURE BOOM IS POSITIONED OVER REAR AXLE. IF BOOM IS OVER FRONT AXLE (STEER WHEELS), STEER AND DRIVE CONTROLS WILL MOVE IN OPPOSITE DIRECTION THAN INDICATED ON MACHINE PLACARDS.

4.6 PARKING AND STOWING

Park and stow machine as follows:

1. Park machine in travel position; boom lowered over rear, all access panels and doors closed and secured, ignition off.
2. Check that brakes hold machine in position.
3. Chock wheels front and rear.
4. Turn off SELECT switch and remove key.

4.7 PLATFORM

Loading From Ground Level

1. Position chassis on a smooth, firm and level surface.
2. If total load (personnel, tools and supplies) is less than rated capacity, distribute load uniformly on platform floor and proceed to work position.

Loading From Positions Above Ground Level

Before loading weight to platform above ground level:

1. Determine what the total rated capacity weight will be after additional weight is loaded (personnel, tools and supplies).
2. If total weight in platform will be less than rated capacity, proceed with adding weight.

Platform Level Adjustment

1. Leveling UP. Depress footswitch To raise platform, position PLATFORM LEVEL control switch UP and hold until platform is level.
2. Leveling DOWN. Depress footswitch To lower platform, position PLATFORM LEVEL control switch to DOWN and hold until platform is level.

Platform Rotation

1. Depress footswitch to rotate platform to the left, PLATFORM ROTATE control is positioned to the LEFT and held until desired position is reached.
2. Depress footswitch to rotate platform to the right, PLATFORM ROTATE control is positioned to the RIGHT and held until desired position is reached.

4.8 BOOM

WARNING

AN ORANGE TILT WARNING LIGHT IS LOCATED ON THE CONTROL CONSOLE WHICH LIGHTS WHEN THE CHASSIS IS ON A 5 DEGREE OR GREATER SLOPE. DO NOT SWING OR RAISE BOOM ABOVE HORIZONTAL WHEN LIGHT IS LIT.

DO NOT DEPEND ON TILT ALARM AS A LEVEL INDICATOR FOR THE CHASSIS. THE TILT ALARM INDICATES THE CHASSIS IS ON A SEVERE SLOPE (3 DEGREE OR GREATER). CHASSIS MUST BE LEVEL BEFORE SWINGING, OR RAISING BOOM ABOVE HORIZONTAL.

TO AVOID MACHINE UPSET IF THE ORANGE TILT WARNING LIGHT ILLUMINATED WHEN THE BOOM IS RAISED ABOVE HORIZONTAL, LOWER THE PLATFORM TO GROUND LEVEL, THEN REPOSITION MACHINE SO THAT CHASSIS IS LEVEL BEFORE RAISING BOOM.

TRAVELING WITH BOOM BELOW HORIZONTAL IS PERMITTED ON GRADES SPECIFIED ON SERIAL NUMBER PLACARD.

TO AVOID SERIOUS INJURY, DO NOT OPERATE MACHINERY IF ANY CONTROL LEVER OR TOGGLE SWITCH CONTROLLING PLATFORM MOVEMENT DOES NOT RETURN TO THE "OFF" POSITION WHEN RELEASED.

TO AVOID A COLLISION AND INJURY IF PLATFORM DOES NOT STOP WHEN A CONTROL SWITCH OR LEVER IS RELEASED, REMOVE FOOT FROM FOOTSWITCH OR USE EMERGENCY STOP SWITCH TO STOP MACHINE.

Swinging the Boom

Depress footswitch to swing boom, with footswitch activated, position SWING control switch to RIGHT or LEFT for direction desired.

IMPORTANT

WHEN SWINGING THE BOOM MAKE SURE THERE IS AMPLE ROOM FOR THE BOOM TO CLEAR SURROUNDING WALLS, PARTITIONS AND EQUIPMENT.

Raising and Lowering the Lower and Mid Boom.

To raise or lower the Lower and Mid Boom, with footswitch activated, position Lower Boom Lift switch to UP or DOWN as desired.

Raising and Lowering the Main (Upper) Boom

NOTE: Lift up will not function when the boom is near full elevation and the platform is out of level.

To raise or lower the Main (Upper) Boom, with footswitch activated, position Upper Boom Lift switch to UP or DOWN until desired height is reached.

Telescoping the Main Boom

To extend or retract the main boom, with the footswitch activated, position the Main Telescope Control Switch to the in or out position and hold until the platform reaches the desired position.

4.9 LIFT UP AND PLATFORM LEVEL DOWN DISABLE SWITCH FUNCTIONAL CHECK

The purpose of the disable switch is to prevent lift up when the boom is near full elevation and the platform is out of level.

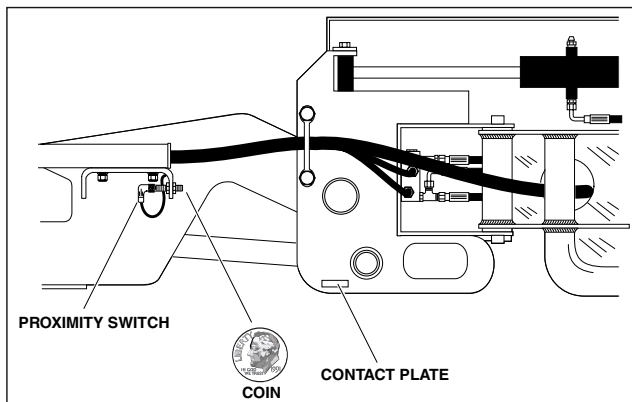

Figure 4-2. Functional Check

⚠ IMPORTANT

DISABLE SWITCH FUNCTIONAL CHECK MUST BE PERFORMED QUARTERLY, ANY TIME A SYSTEM COMPONENT IS REPLACED, OR WHEN IMPROPER SYSTEM OPERATION IS SUSPECTED.

1. Tape a small piece of metal to the end of the limit switch (e.g. a coin).
2. Using the controls in the platform basket, test the lift up and platform level down functions. Both operations should be locked out and not function.
3. Remove metal (coin) and return machine to service.

4.10 SHUT DOWN AND PARK

4. Drive machine to a protected area.
5. Assure main boom is fully retracted and lowered over rear (Drive) axle; all access panels and doors closed and secured.
6. Remove all load and allow engine to operate 3-5 minutes at LOW setting to permit reduction of engine internal temperatures.
7. At Ground Controls, turn KEY SELECT switch to (center) OFF. Position, POWER/EMERGENCY STOP switch (down) to OFF. Remove key.
8. Cover Platform Control console to protect instruction placards, warning decals and operating controls from hostile environment.

4.11 TIE DOWN AND LIFTING

When transporting machine, boom must be in the stowed mode and machine securely tied down to truck or trailer deck. Four tie down eyes are provided in the frame slab, one at each corner of the machine. (See Figure 4-3. and Figure 4-4.)

If it becomes necessary to lift the machine using an overhead or mobile crane, it is very important that the lifting devices are attached only to the designated lifting eyes. (See Figure 4-5. Lifting Chart)

NOTE: Crane and lifting devices, chains, slings, etc., must be capable of handling at least:

- 450A - 2WD (pneumatic tires) - 6668 kg. (14,700 lbs.)
- 450AJ - 2WD (pneumatic tires) - 7030 kg. (15,500 lbs.)
- 450A - 2WD (foam-filled tires) - 6985 kg. (15,400 lbs.)
- 450AJ - 2WD (foam-filled tires) - 7122 kg. (15,700 lbs.)

⚠ IMPORTANT

ABOVE ARE MINIMUM WEIGHTS. CHECK WEIGHT OF UNIT PRIOR TO LIFTING.

NOTE: Lifting eyes are provided at the front and rear in the frame slab. Each of the four chains or slings used for lifting machine must be adjusted individually so machine remains level when elevated.

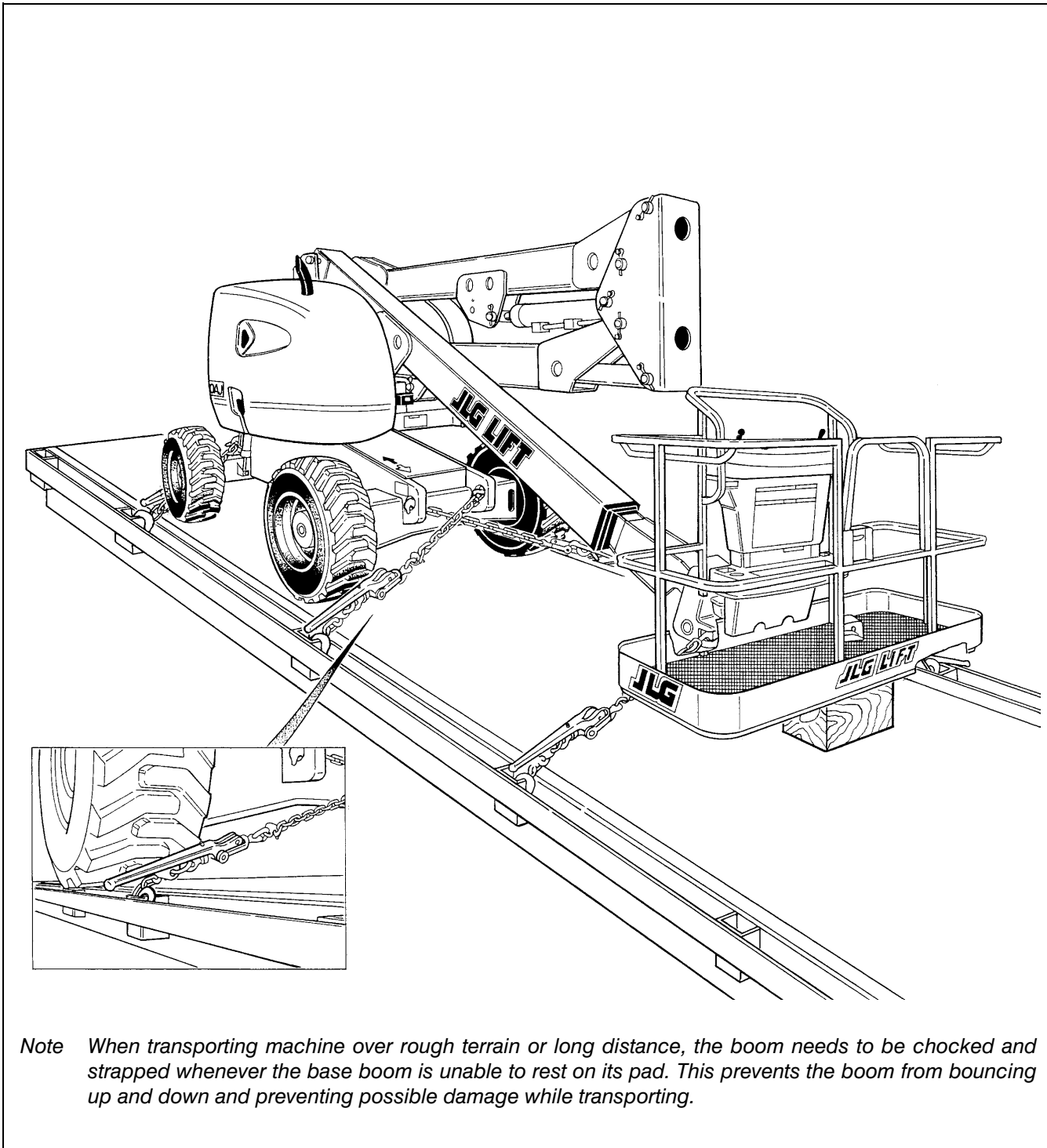

Figure 4-3. Machine Tie Down - A Models

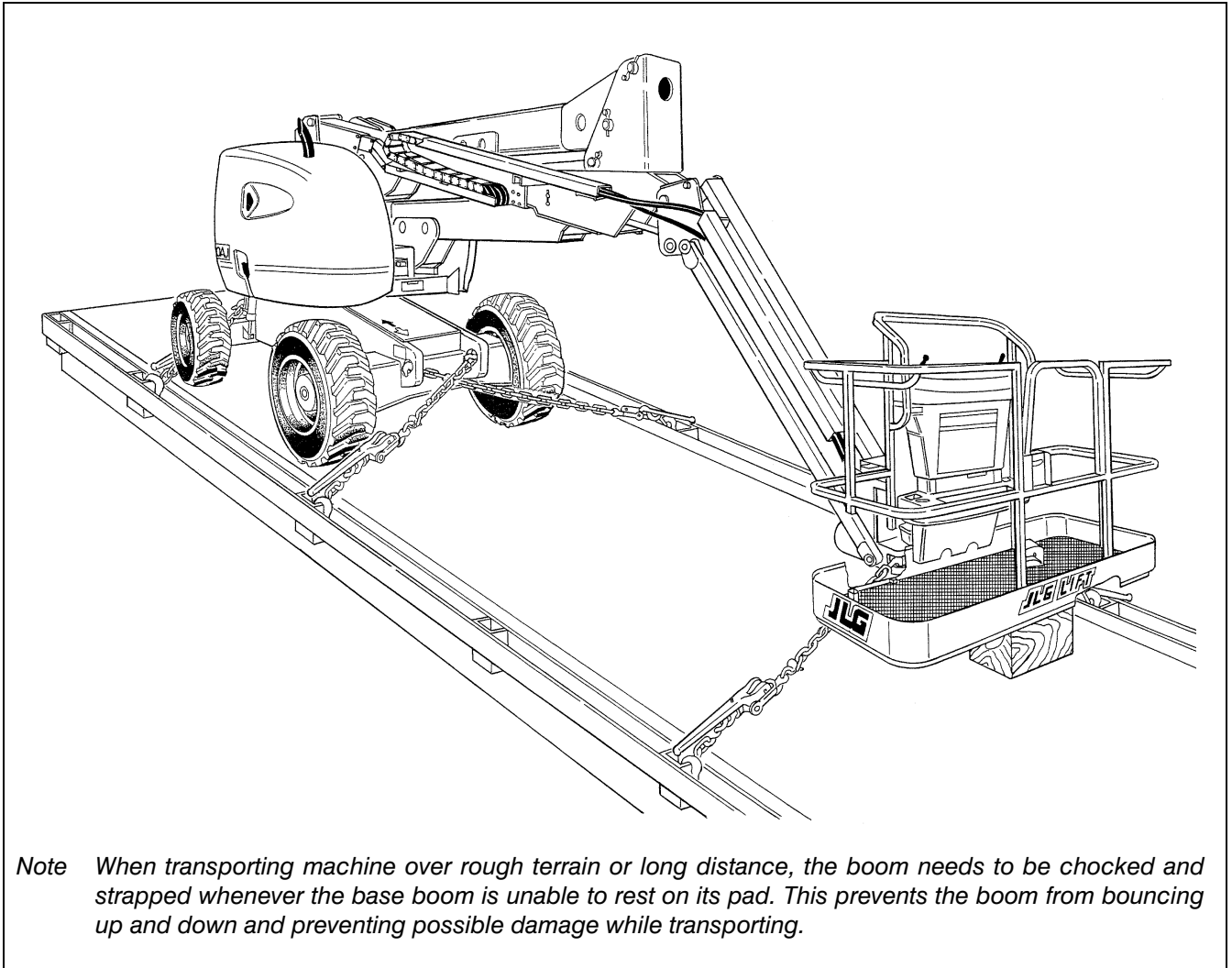

Figure 4-4. Machine Tie Down - AJ Models

LIFTING DIAGRAM

MODEL	Tire option	Minimum Gross Weight Standard Machine
450A	pneumatic	14,700 lbs. (6668 kg)
450AJ	pneumatic	15,500 lbs. (7030 kg)
450A	foam-filled	15,400 lbs. (6985 kg)
450AJ	foam-filled	15,700 lbs. (7122 kg)

LIFTING INSTRUCTIONS

- Place boom in the stowed position
- Remove all loose items from machine.
- Properly adjust rigging to prevent damage to machine and so machine remains level.

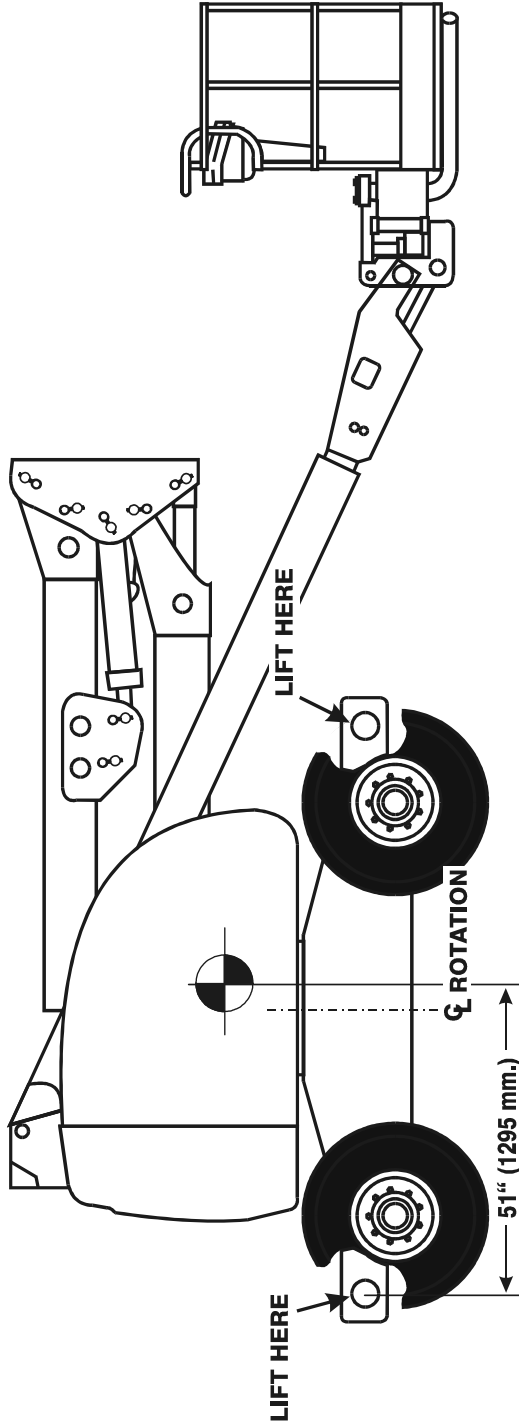

Figure 4-5. Lifting Chart

4.12 OSCILLATING AXLE LOCKOUT TEST (IF EQUIPPED)

IMPORTANT

LOCKOUT SYSTEM TEST MUST BE PERFORMED QUARTERLY, ANY TIME A SYSTEM COMPONENT IS REPLACED, OR WHEN IMPROPER SYSTEM OPERATION IS SUSPECTED.

NOTE: *Ensure boom is fully retracted, lowered, and centered between drive wheels prior to beginning lockout cylinder test.*

1. Place a 15 cm high block with ascension ramp in front of left front wheel.
2. From platform control station, start engine.
3. Place HIGH ENGINE, DRIVE SPEED and WHEEL MOTOR SPEED (if equipped) control switches to their respective LOW positions
4. Place DRIVE control lever to FORWARD position and carefully drive machine up ascension ramp until left front wheel is on top of block.
5. Carefully activate SWING control lever and position boom over right side of machine.
6. With boom over right side of machine, place DRIVE control lever to REVERSE and drive machine off of block and ramp.
7. Have an assistant check to see that left front wheel remains locked in position off of ground.
8. Carefully activate SWING control lever and return boom to stowed position (centered between drive wheels). When boom reaches center, stowed position, lockout cylinders should release and allow wheel to rest on ground, it may be necessary activate DRIVE to release cylinders.
9. Place the 15 cm high block with ascension ramp in front of right front wheel.
10. Place DRIVE control lever to FORWARD and carefully drive machine up ascension ramp until right front wheel is on top of block.
11. Carefully activate SWING control lever and position boom over left side of machine.
12. With boom over left side of machine, place DRIVE control lever to REVERSE and drive machine off of block and ramp.
13. Have an assistant check to see that right front wheel remains locked in position off of ground.
14. Carefully activate SWING control lever and return boom to stowed position (centered between drive wheels). When boom reaches center, stowed position, lockout cylinders should release and allow wheel to rest on ground, it may be necessary activate DRIVE to release cylinders.
15. If lockout cylinders do not function properly, have qualified personnel correct the malfunction prior to any further operation.

SECTION 4 - MACHINE OPERATION

4.13 TOWING

⚠ WARNING

RUNAWAY VEHICLE/MACHINE HAZARD. MACHINE HAS NO TOWING BRAKES. TOWING VEHICLE MUST BE ABLE TO CONTROL MACHINE AT ALL TIMES. ON-HIGHWAY TOWING NOT PERMITTED. FAILURE TO FOLLOW INSTRUCTIONS COULD CAUSE SERIOUS INJURY OR DEATH.

MAXIMUM TOWING SPEED 8 K.M.H. (5 M.P.H.) FOR NO LONGER THAN 30-45 MINUTES.

MAXIMUM TOWING GRADE 25%.

Prior to towing the machine, complete the following:

⚠ CAUTION

DO NOT TOW MACHINE WITH ENGINE OPERATING OR DRIVE HUBS ENGAGED.

1. Retract, lower and position boom over rear drive wheels in line with direction of travel.
2. Disconnect drive hubs by inverting disconnect cap. (See Figure 4-6.) After towing the machine, complete the following:

3. Reconnect drive hubs by inverting disconnect cap. (See Figure 4-6.)

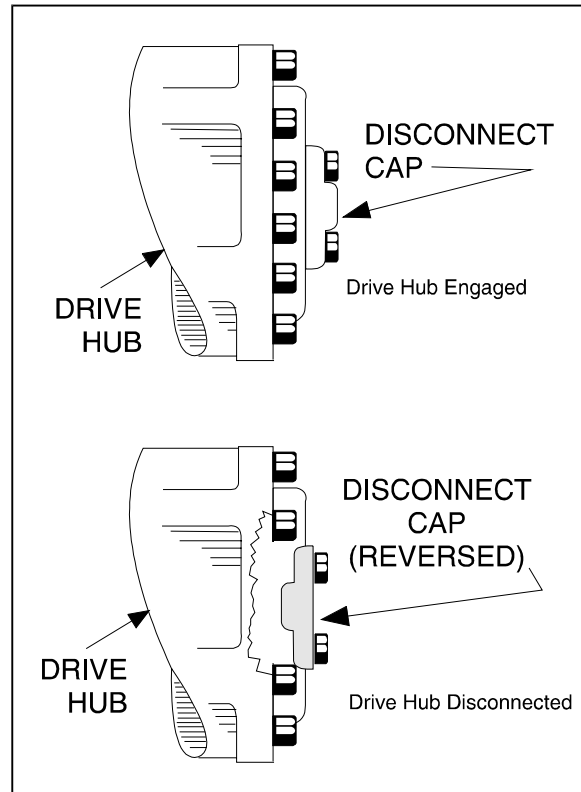

Figure 4-6. Drive Disconnect Hub

SECTION 5. OPTIONAL EQUIPMENT

5.1 DUAL FUEL SYSTEM (GAS ENGINE ONLY)

Description

The dual fuel system enables the standard gasoline engine to run on either gasoline or LP gas. The system includes pressurized cylinders mounted on the frame, and the valves and switches needed to switch the fuel supply from gasoline to LP gas or from LP gas to gasoline.

A two position, FUEL SELECT toggle switch at the platform control station supplies electrical power to open the gasoline shut-off solenoid and close the LP gas shut off solenoid when positioned to the GASOLINE position. This switch supplies electrical power to open the LP gas shut-off solenoid and close the gasoline shut-off solenoid when positioned to the LP position.

⚠ CAUTION

IT IS POSSIBLE TO SWITCH FROM ONE FUEL SOURCE TO THE OTHER WITHOUT ALLOWING THE ENGINE TO STOP. EXTREME CARE MUST BE TAKEN AND THE FOLLOWING INSTRUCTIONS MUST BE FOLLOWED.

Changing From Gasoline to LP Gas

1. Start engine from Ground Control Station.
2. Open hand valve on LP gas supply tank by turning counterclockwise.
3. While engine is operating on GASOLINE under a no-load condition, place FUEL SELECT switch at Platform Control to LP position.

Changing From LP Gas to Gasoline

1. With engine operating on LP under a no-load condition, position FUEL SELECT switch at Platform Control Station to GASOLINE position.
2. Close hand valve on LP gas supply tank by turning clockwise.

5.2 OSCILLATING AXLE

The oscillating front axle is attached to the frame by a pivot pin which allows all four wheels to remain on the ground when traveling on rough terrain. The oscillating axle also incorporates two lockout cylinders connected between the frame and each wheel end. The lockout cylinders permit axle oscillation when the boom is centered over the rear, and lock and hold the axle when the boom is moved off center.

5.3 PLATFORM W/SOFT TOUCH PROXIMITY SYSTEM BUMPER

This optional system incorporates a lower padded rail, slightly larger than the platform. Four Proximity switches are attached to each corner of the lower rail. The proximity switches are set so that when the antenna comes into contact with an object, electrical power is cut off from the platform controls, shutting down all functions.

5.4 FOUR WHEEL DRIVE

Provides drive motors, brakes (rear only) and torque hubs at each wheel to give extra traction. The system is available with either a fixed or oscillating front axle.

5.5 COLD WEATHER PACKAGE

Deutz Engine with Glow Plugs

The glow plugs are installed in the engine and automatically come on with the ignition circuit and remain on for a period of seven seconds.

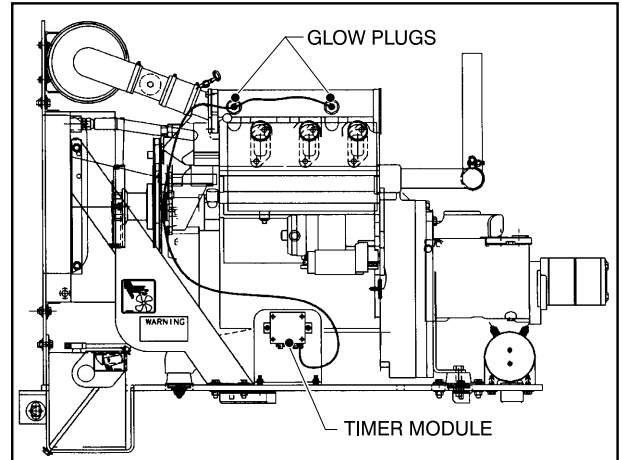

In addition to the glow plugs, the cold weather package also includes an electric immersion heater for the hydraulic oil tank, and an electric blanket type heater for the battery. These components can be plugged in together or singly to preheat their associated components for easier cold weather starting.

Deutz Engine with Ether Start

The ether start system in the diesel engine functions automatically to provide starting fluid, as necessary, to the engine. A sensor switch mounted on the engine will permit ether injection when the engine is cold. The sensor will not permit ether injection to a warm engine.

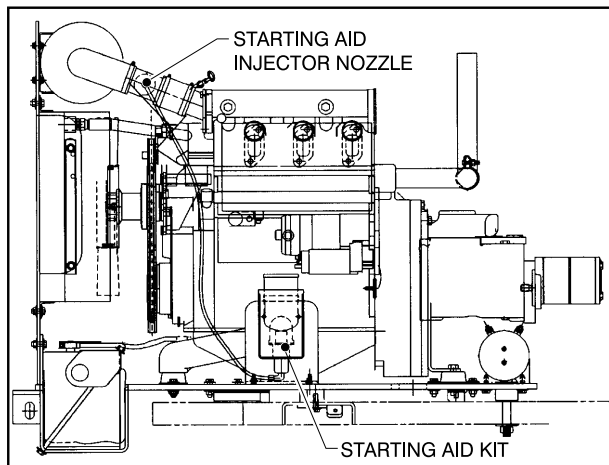

In addition to the ether start system, the cold weather package also includes an electric immersion heater for the hydraulic oil tank, and an electric blanket type heater for the battery. These components can be plugged in together or singly to preheat their associated components for easier cold weather starting.

Isuzu Engine

The cold weather package for the Isuzu engine consists of the engine block heater (an electrical heater installed in the left front core plug hole), an electric immersion heater for the hydraulic oil tank, and an electric blanket type heater for the battery. These components can be plugged in together or singly to preheat their associated components for easier cold weather starting.

Ford Engine

Two different options are available for cold weather with the Ford engine; an engine block heater and a cold weather package which also includes the engine block heater.

The engine block heater is an electrical heater installed in the left (intake side) core plug hole. When plugged in, it heats the engine coolant to warm the engine prior to starting.

The cold weather package consists of the engine block heater mentioned above, an immersion heater for the hydraulic oil tank, and an electric blanket type heater for the battery. These components can be plugged in together or singly to preheat their associated components for easier cold weather starting.

5.6 TRAVEL ALARM

A 12-volt alarm horn, mounted on the turntable, provides an audible warning when the machine is in the travel (DRIVE) mode. It will function in FORWARD or REVERSE to warn jobsite personnel the machine is traveling.

5.7 ELECTRIC GENERATOR

An electric generator mounted on the machine functions to supply electrical power to the platform. This device will provide enough power to run assorted power tools.

5.8 ROTATING BEACON

An amber or red rotating beacon may be installed on the hood or platform, and can be controlled by a two position toggle switch mounted on the platform control console. When the switch is placed in the ON position, the light is activated and provides a visual warning to the machine's operation.

5.9 CYLINDER BELLOWS

A one piece accordion shaped rubber bellows may be attached to the rod end of the cylinder barrel and to the cylinder rod as close to the rod attach bushing as possible. The bellows affords protection to the cylinder rod in either the extended or retracted position. The bellows are installed on the lift cylinder, slave cylinder, master cylinder and steer cylinder.

5.10 BOOM WIPERS

A one piece U-shaped neoprene strip, be attached to the front of the base boom section, wipes the top and both sides of the fly section. The bottom side of the fly section is protected by a straight neoprene strip which also attaches to the base section.

5.11 HOSTILE ENVIRONMENT PACKAGE

The hostile environment package provides additional protection against the entry of dust, dirt, sand and other abrasive materials into the hydraulic system, control handles and switches, cylinders, boom wire ropes and wear pads, and the air inlet of the engine. The package is intended for machines that will be exposed to painting, sandblasting or other similar hostile conditions. The hostile environment package includes boom wipers, cylinder bellows, heavy duty reservoir breather, an engine air cleaner and control console cover, as required.

5.12 MOTION ALARM

A motion alarm horn provides an audible warning when the platform controls are selected at the PLATFORM/GROUND SELECT switch, the POWER/EMERGENCY STOP switch is ON, and the footswitch is depressed. The alarm warns personnel in the jobsite area to avoid the operating machine.

5.13 SEMI-TRACK

The semi-track option consists of steel tracks and idler wheels. The idler wheels are mounted to the chassis just forward of the drive wheels. The steel tracks are installed around the drive wheels and idler wheels. This option provides increased traction for operation in rough terrain.

This page left blank intentionally.

SECTION 6. EMERGENCY PROCEDURES

6.1 GENERAL

This section provides information on the procedures to be followed and on the systems and controls to be used in the event an emergency situation is encountered during machine operation. Prior to operation of the machine and periodically thereafter, the entire operating manual, including this section, should be reviewed by all personnel whose responsibilities include any work or contact with the machine.

6.2 EMERGENCY TOWING PROCEDURES

Towing this machine is prohibited, unless properly equipped. However, provisions for moving the machine, in case of a malfunction or power failure, have been incorporated. The following procedures are to be used **ONLY** for emergency movement to a suitable maintenance area.

1. Chock wheels securely.
2. Disengage drive hubs by reversing disconnect caps.
3. Connect suitable equipment, remove chocks, and move machine.

After moving machine, complete the following procedures:

1. Position machine on a firm and level surface.
2. Chock wheels securely.
3. Engage drive hubs by reversing disconnect caps on hubs.
4. Remove chocks from wheels as needed.

6.3 EMERGENCY CONTROLS AND THEIR LOCATIONS

Power/Emergency Stop Switches

1. There is one of these red mushroom shaped switches at both the Ground Controls and Platform Controls. When depressed it will immediately stop the machine.

WARNING

CHECK MACHINE DAILY TO MAKE SURE EMERGENCY STOP SWITCH GUARD IS IN PLACE AND THAT GROUND CONTROL INSTRUCTIONS ARE IN PLACE AND LEGIBLE.

2. Installed on the Platform Console, this round red switch is pulled up for normal machine functions. In an emergency, push the button to the down position with your palm and machine will immediately stop.

Ground Control Station

The Ground Control Station is located on the right front side of the turntable. The controls on this panel provide the means for overriding the platform controls, and for controlling the boom and swing functions from the ground. Place the KEY SELECT switch to GROUND position and operate the proper switch to lift, swing, or telescope the boom, or level the platform.

Auxiliary Power

A toggle type auxiliary power control switch is located on the platform control station and another is located on the ground control station. Operation of either switch turns on the electrically driven auxiliary hydraulic pump. This should be used in case of failure of the main power plant. The auxiliary pump will operate boom lift, telescope and swing. To activate auxiliary power:

1. Position PLATFORM/GROUND SELECT KEY SWITCH to PLATFORM.
2. Position POWER/EMERGENCY STOP switch to ON.
3. Depress and hold footswitch.
4. Operate appropriate control switch, lever or controller for desired function and hold.
5. Position AUXILIARY POWER switch to ON and hold.
6. Release AUXILIARY POWER switch, selected control switch, lever or controller, and footswitch.
7. Position POWER/EMERGENCY STOP switch to OFF.

To activate auxiliary power from the ground control station:

1. Position PLATFORM/GROUND SELECT KEY SWITCH to GROUND.
2. Position POWER/EMERGENCY STOP switch to ON.
3. Operate appropriate control switch or controller for desired function and hold.
4. Position AUXILIARY POWER switch to ON and hold.
5. Release AUXILIARY POWER switch, and appropriate control switch or controller.
6. Position POWER/EMERGENCY STOP switch to OFF.

6.4 EMERGENCY OPERATION

Use of Ground Controls

KNOW HOW TO USE THE GROUND CONTROLS IN AN EMERGENCY SITUATION.

Ground personnel must be thoroughly familiar with the machine operating characteristics and the ground control functions. Training should include operation of the machine, review and understanding of this section and hands-on operation of the controls in simulated emergencies.

Operator Unable to Control Machine

IF THE PLATFORM OPERATOR IS PINNED, TRAPPED OR UNABLE TO OPERATE OR CONTROL THE MACHINE:

⚠ WARNING

DO NOT OPERATE WITH PRIMARY POWER SOURCE (ENGINE OR ELECTRIC MOTOR) IF PERSONS ARE PINNED OR TRAPPED. USE AUXILIARY POWER INSTEAD.

1. Operate the machine from ground controls ONLY with the assistance of other personnel and equipment (cranes, overhead hoists, etc.) as may be required to safely remove the danger or emergency condition.
2. Other qualified personnel on the platform may use the platform controls with regular or auxiliary power. DO NOT CONTINUE OPERATION IF CONTROLS DO NOT FUNCTION NORMALLY.
3. Cranes, forklift trucks or other equipment which may be available are to be used to remove platform occupants and stabilize motion of the machine in case machine controls are inadequate or malfunction when used.

Platform or Boom Caught Overhead

If the platform or boom becomes jammed or snagged in overhead structures or equipment, do not continue operation of the machine from either the platform or the ground until the operator and all personnel are safely moved to a secure location. Only then should an attempt be made to free the platform using any necessary equipment and personnel. Do not operate controls to cause one or more wheels to leave the ground.

Post Incident Inspection and Repair

Following any incident, thoroughly inspect the machine and test all functions first from the ground controls, then from the platform controls. Do not lift above 3 m (10 feet) until you are sure that all damage has been repaired, if required, and that all controls are operating correctly. A cold weather start system in the diesel engine functions automatically to provide starting fluid, as necessary, to the engine. A sensor switch mounted on the engine will permit ether injection when the engine is cold. The sensor will not permit ether injection to a warm engine.

6.5 INCIDENT NOTIFICATION

It is imperative that JLG Industries, Inc. be notified immediately of any incident involving a JLG product. Even if no injury or property damage is evident, the factory should be contacted by telephone and provided with all necessary details.

Contact your local JLG office.

It should be noted that failure to notify the manufacturer of an incident involving a JLG Industries product within 48 hours of such an occurrence may void any warranty consideration on that particular machine.



TRANSFER OF OWNERSHIP

To: JLG, Gradall, Lull and Sky Trak product owner:

If you now own, but ARE NOT the original purchaser of the product covered by this manual, we would like to know who you are. For the purpose of receiving safety-related bulletins, it is very important to keep JLG Industries, Inc. updated with the current ownership of all JLG products. JLG maintains owner information for each JLG product and uses this information in cases where owner notification is necessary.

Please use this form to provide JLG with updated information with regard to the current ownership of JLG Products. Please return completed form to the JLG Product Safety & Reliability Department via facsimile (717) 485-6573 or mail to address as specified on the back of this form.

Thank you,
Product Safety & Reliability Department
JLG Industries, Inc.
1 JLG Drive
McConnellsburg, PA 17233-9533
Telephone: (717) 485-5161
Fax: (717) 485-6573

NOTE: Leased or rented units should not be included on this form.

Mfg. Model: _____

Serial Number: _____

Previous Owner: _____

Address: _____

City: _____ State: _____

Zip: _____ Telephone: (_____) _____

Date Of Transfer: _____

Current Owner: _____

Address: _____

City: _____ State: _____

Zip: _____ Telephone: (_____) _____

Who in your organization should we notify?

Name: _____

Title: _____

Please cut on the dotted line and fax to 717-485-6573





Corporate Office
JLG Industries, Inc.
1 JLG Drive
McConnellsburg PA. 17233-9533
USA
Phone: (717) 485-5161
Customer Support Toll Free: (877) 554-5438
Fax: (717) 485-6417

JLG Worldwide Locations

JLG Industries (Australia)
P.O. Box 5119
11 Bolwarra Road
Port Macquarie
N.S.W. 2444
Australia
Phone: (61) 2 65 811111
Fax: (61) 2 65 810122

JLG Industries (UK)
Unit 12, Southside
Bredbury Park Industrial Estate
Bredbury
Stockport
SK6 2sP
England
Phone: (44) 870 200 7700
Fax: (44) 870 200 7711

JLG Deutschland GmbH
Max Planck Strasse 21
D-27721 Ritterhude/Idpohl
Bei Bremen
Germany
Phone: (49) 421 693 500
Fax: (49) 421 693 5035

JLG Industries (Italia)
Via Po. 22
20010 Pregnana Milanese - MI
Italy
Phone: (39) 02 9359 5210
Fax: (39) 02 9359 5845

JLG Latino Americana Ltda.
Rua Eng. Carlos Stevenson,
80-Suite 71
13092-310 Campinas-SP
Brazil
Phone: (55) 19 3295 0407
Fax: (55) 19 3295 1025

JLG Europe B.V.
Jupiterstraat 234
2132 HJ Foofddorp
The Netherlands
Phone: (31) 23 565 5665
Fax: (31) 23 557 2493

JLG Industries (Norge AS)
Sofeimyrveien 12
N-1412 Sofienyr
Norway
Phone: (47) 6682 2000
Fax: (47) 6682 2001

JLG Polska
Ul. Krolewska
00-060 Warszawa
Poland
Phone: (48) 91 4320 245
Fax: (48) 91 4358 200

JLG Industries (Europe)
Kilmartin Place,
Tannochside Park
Uddingston G71 5PH
Scotland
Phone: (44) 1 698 811005
Fax: (44) 1 698 811055

JLG Industries (Pty) Ltd.
Unit 1, 24 Industrial Complex
Herman Street
Meadowdale
Germiston
South Africa
Phone: (27) 11 453 1334
Fax: (27) 11 453 1342

Plataformas Elevadoras
JLG Iberica, S.L.
Trapadella, 2
P.I. Castellbisbal Sur
08755Castellbisbal
Spain
Phone: (34) 93 77 24700
Fax: (34) 93 77 11762

JLG Industries (Sweden)
Enkopingsvagen 150
Box 704
SE - 175 27 Jarfalla
Sweden
Phone: (46) 8 506 59500
Fax: (46) 8 506 59534
